

KORKULUK MODELLERİ



K-100



K-101



K-102

K-102-A= 60 * 39 cm



K-103

K-103-A= 40*39 cm



K-104



K-105



* Tüm Korkuluklar Üzerindeki Demir Pimleri Vasıtasıyla, Kaynak Yapılabilir. / * All The Steel Bolts On The Railings Permit Welding.



Malzeme : Alüminyum Döküm veya Pük Döküm yapılıır.
Boya&Renk: Boyasız (isteğe göre boyanır)
Bazı ürün ölçüleri yazım hatasından dolayı farklı olabilir.

Material : Aluminum Cast & Cast Iron
Paint &Colours: Unpainted (painting depending on request)
The measurements of some of the products can vary due to writing errors

KORKULUK MODELLERİ



200 cm

39 cm

K-106



100 cm

25 cm

K-107



74 cm

25 cm

K-108



72 cm

27 cm

K-109



79 cm

42 cm

K-110



* Tüm Korkuluklar Üzerindeki Demir Pimleri Vasıtasıyla, Kaynak Yapılabilir. / * All The Steel Bolts On The Railings Permit Welding.



Malzeme : Alüminyum Döküm veya Pik Döküm yapılıdır.
Boya&Renk: Boyasız (isteğe göre boyanır)
Bazı ürün ölçüleri yazım hatasından dolayı farklı olabilir.

Material : Aluminum Cast & Cast Iron
Paint &Colours: Unpainted (painting depending on request)
The measurements of some of the products can vary due to writing errors

KORKULUK MODELLERİ



130 cm

K-111

25 cm



36 cm

K-112

25 cm

81 cm



25 cm

K-113

K-113-A=70*25 cm

80 cm



26 cm

K-114

K-114-A=70 * 25 cm

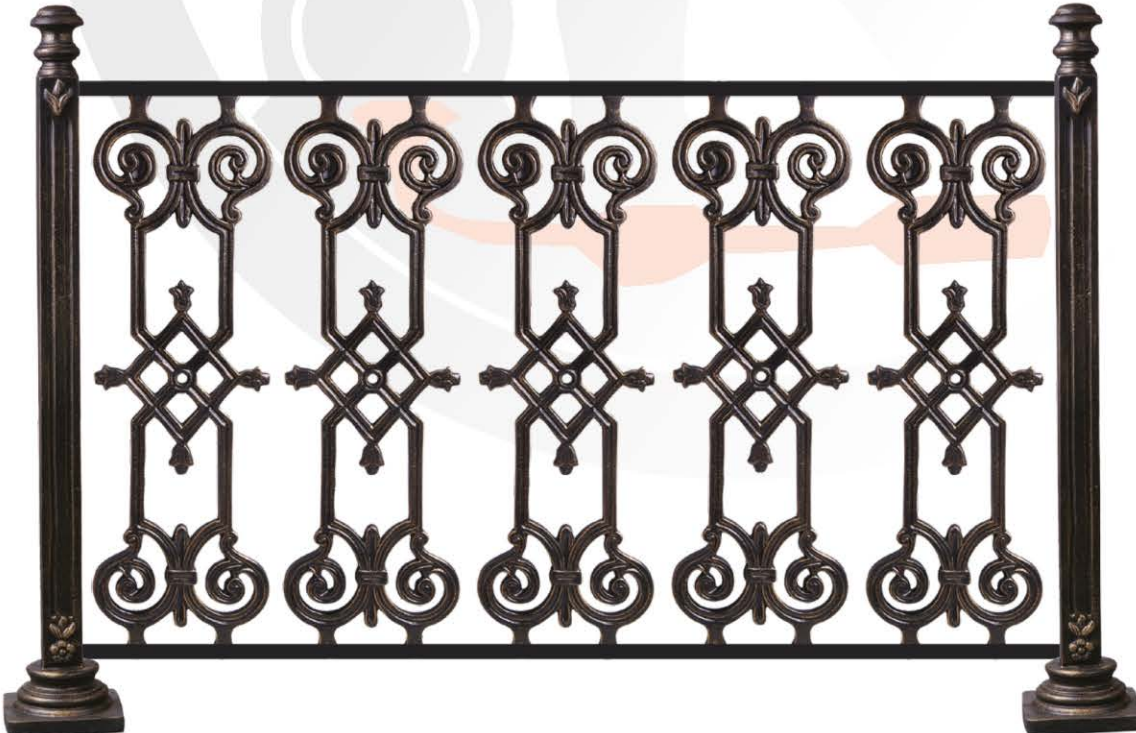

83 cm



32 cm

K-115

* Tüm Korkuluklar Üzerindeki Demir Pimleri Vasıtasıyla, Kaynak Yapılabilir. / * All The Steel Bolts On The Railings Permit Welding.



Malzeme : Alüminyum Döküm veya Pik Döküm yapılıdır.
Boya&Renk: Boyasız (isteğe göre boyanır)
Bazı ürün ölçüleri yazım hatasından dolayı farklı olabilir.

Material : Aluminum Cast & Cast Iron
Paint &Colours: Unpainted (painting depending on request)
The measurements of some of the products can vary due to writing errors

KORKULUK MODELLERİ



K-121

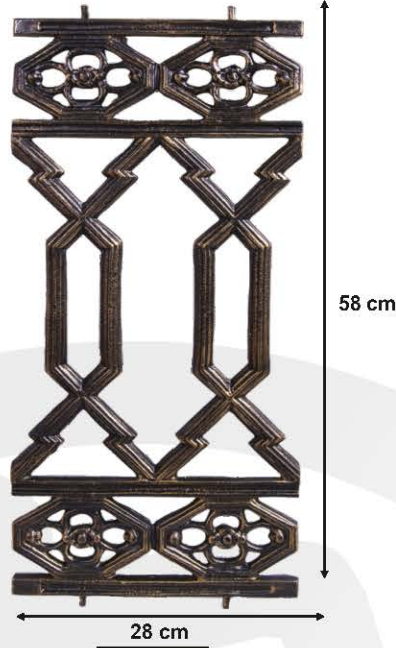

K-122

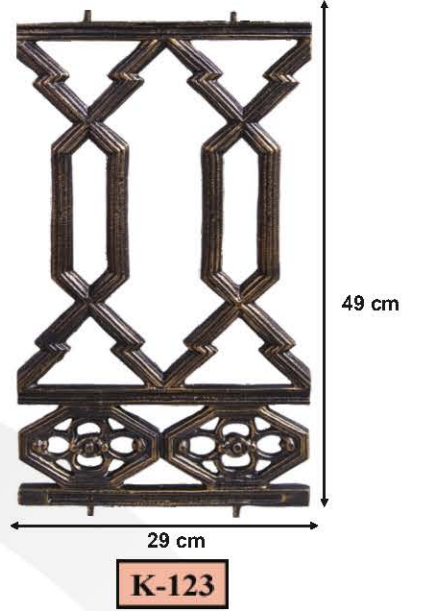

K-123

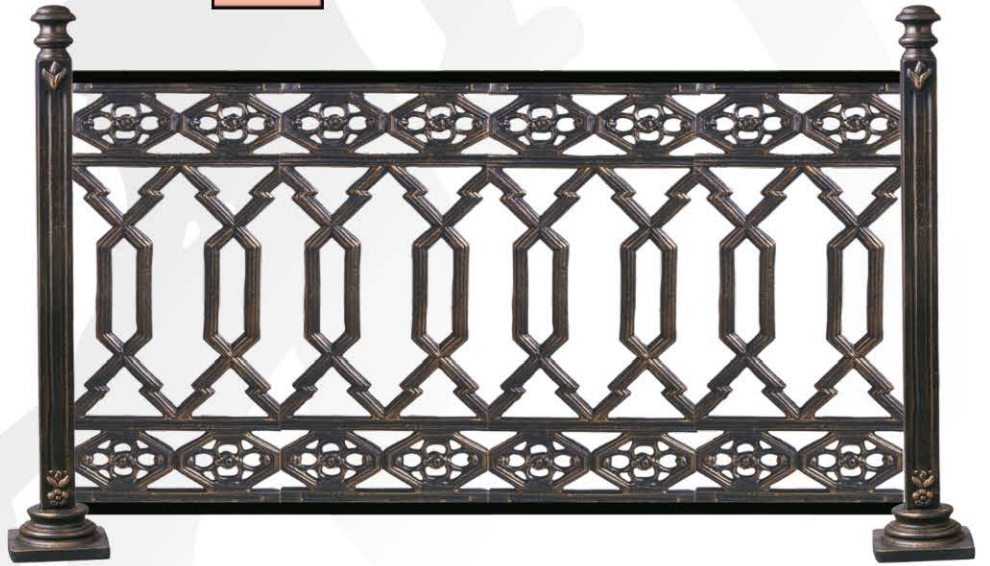

80 cm



25 cm

K-124



* Tüm Korkuluklar Üzerindeki Demir Pimleri Vasıtasıyla, Kaynak Yapılabilir. / * All The Steel Bolts On The Railings Permit Welding.



Malzeme : Alüminyum Döküm veya Pik Döküm yapılıdır.
Boya&Renk: Boyasız (isteğe göre boyanır)
Bazı ürün ölçüleri yazım hatasından dolayı farklı olabilir.

Material : Aluminum Cast & Cast Iron
Paint & Colours: Unpainted (painting depending on request)
The measurements of some of the products can vary due to writing errors

KORKULUK MODELLERİ



53 cm

K-125

83.5 cm



34 cm

K-126

68 cm



21 cm

K-127

58 cm



56 cm

K-128

44 cm



* Tüm Korkuluklar Üzerindeki Demir Pimleri Vasıtasıyla, Kaynak Yapılabilir. / * All The Steel Bolts On The Railings Permit Welding.



Malzeme : Alüminyum Döküm veya Pik Döküm yapılıdır.
Boya&Renk: Boyasız (isteğe göre boyanır)
Bazı ürün ölçüleri yazım hatasından dolayı farklı olabilir.

Material : Aluminum Cast & Cast Iron
Paint &Colours: Unpainted (painting depending on request)
The measurements of some of the products can vary due to writing errors

KORKULUK MODELLERİ



K-129



K-130

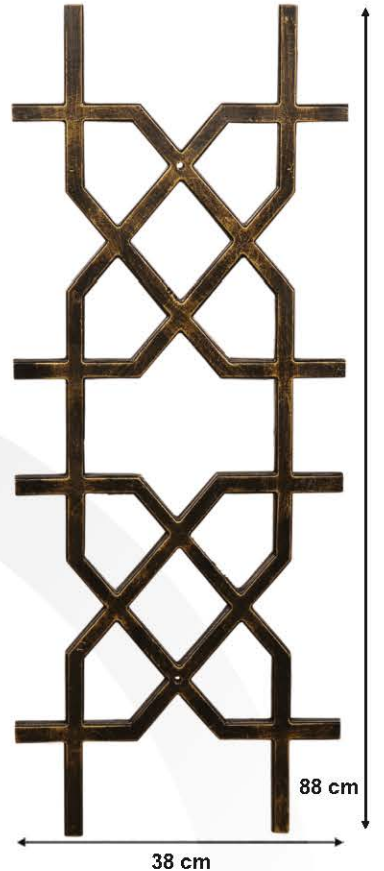

K-131



K-194



K-133



K-134

CUMBALI



K-135

CUMBALI

* Tüm Korkuluklar Üzerindeki Demir Pimleri Vasıtasıyla, Kaynak Yapılabilir. / * All The Steel Bolts On The Railings Permit Welding.



Malzeme : Alüminyum Döküm veya Pik Döküm yapılıdır.
Boya&Renk: Boyasız (isteğe göre boyanır)
Bazı ürün ölçüleri yazım hatasından dolayı farklı olabilir.

Material : Aluminum Cast & Cast Iron
Paint & Colours: Unpainted (painting depending on request)
The measurements of some of the products can vary due to writing errors

KORKULUK MODELLERİ

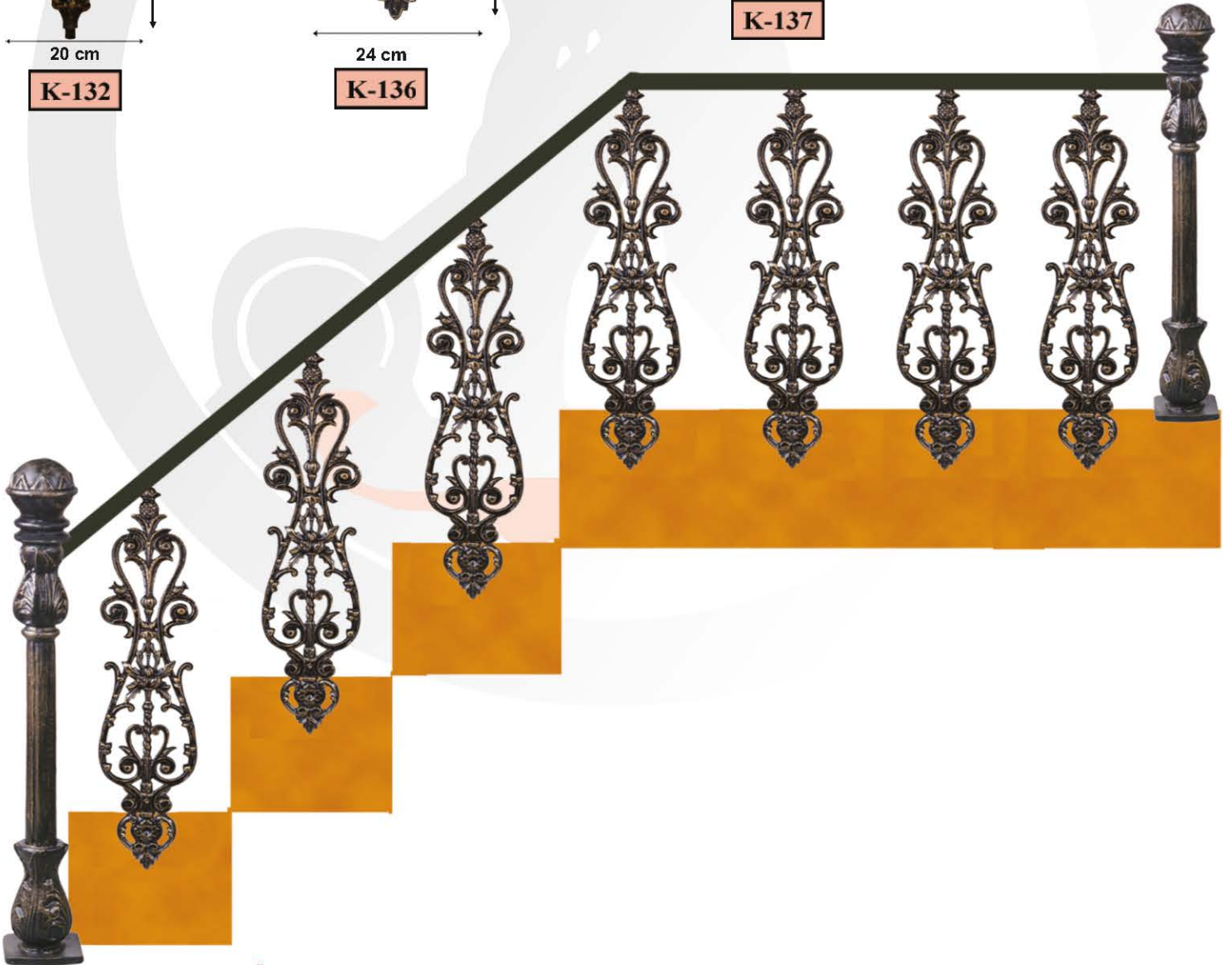

* Tüm Korkuluklar Üzerindeki Demir Pimleri Vasıtasıyla, Kaynak Yapılabilir. / * All The Steel Bolts On The Railings Permit Welding.



Malzeme : Alüminyum Döküm veya Pik Döküm yapılır.
Boya&Renk: Boyasız (isteğe göre boyanır)
Bazı ürün ölçüleri yazım hatasından dolayı farklı olabilir.

Material : Aluminum Cast & Cast Iron
Paint & Colours: Unpainted (painting depending on request)
The measurements of some of the products can vary due to writing errors

KORKULUK MODELLERİ



23 cm

K-139



19 cm

K-140

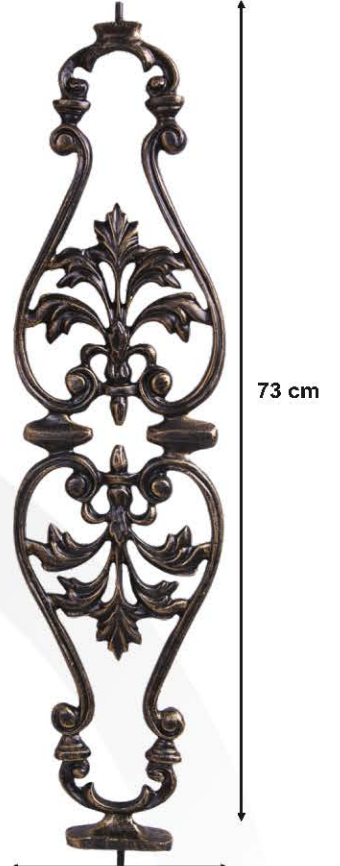

15 cm

K-141



38 cm

K-116

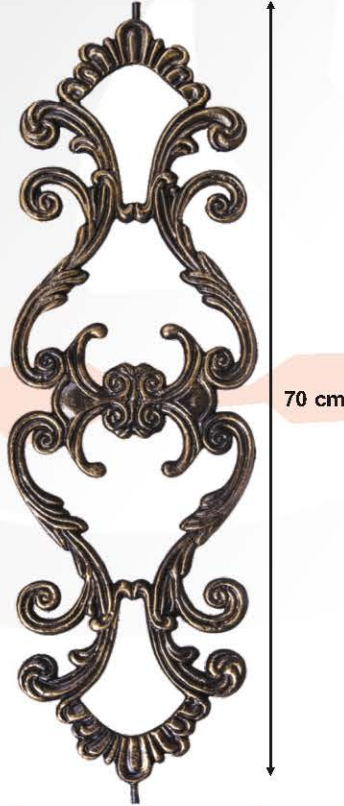

22 cm

K-142

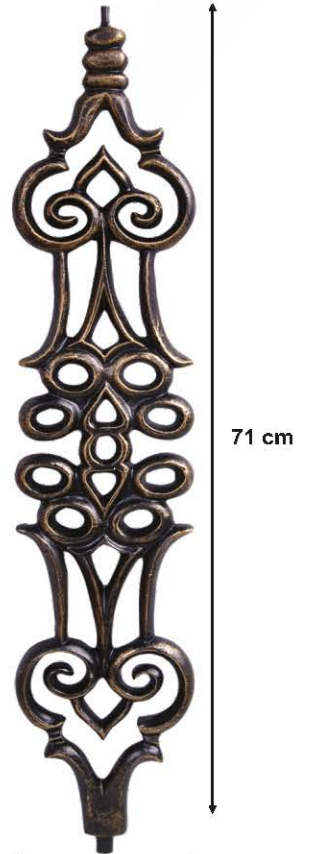

15 cm

K-144

* Tüm Korkuluklar Üzerindeki Demir Pimleri Vasıtasıyla, Kaynak Yapılabilir. / * All The Steel Bolts On The Railings Permit Welding.



Malzeme : Alüminyum Döküm veya Pik Döküm yapılıdır.
Boya&Renk: Boyasız (isteğe göre boyanır)
Bazı ürün ölçüleri yazım hatasından dolayı farklı olabilir.

Material : Aluminum Cast & Cast Iron
Paint & Colours: Unpainted (painting depending on request)
The measurements of some of the products can vary due to writing errors

KORKULUK MODELLERİ

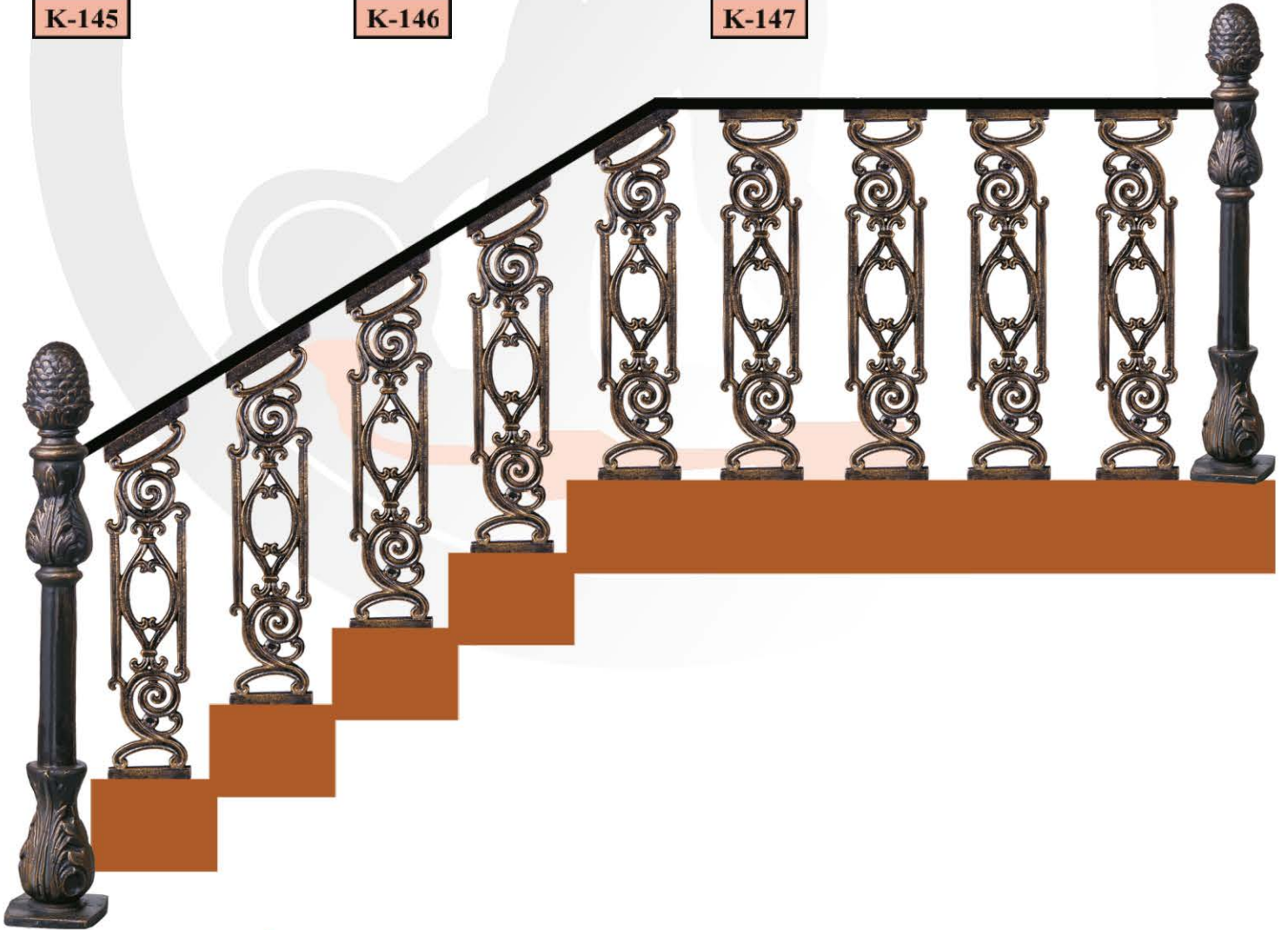

* Tüm Korkuluklar Üzerindeki Demir Pimleri Vasıtasıyla, Kaynak Yapılabilir. / * All The Steel Bolts On The Railings Permit Welding.



Malzeme : Alüminyum Döküm veya Pik Döküm yapılıdır.
Boya&Renk: Boyasız (isteğe göre boyanır)
Bazı ürün ölçüleri yazım hatasından dolayı farklı olabilir.

Material : Aluminum Cast & Cast Iron
Paint &Colours: Unpainted (painting depending on request)
The measurements of some of the products can vary due to writing errors

KORKULUK MODELLERİ



77 cm

18 cm

K-149

K-149-A= 70 * 18 cm



77 cm

18 cm

K-150

K-150-A= 70 * 18 cm



83 cm

23 cm

K-119



88 cm

19 cm

K-152

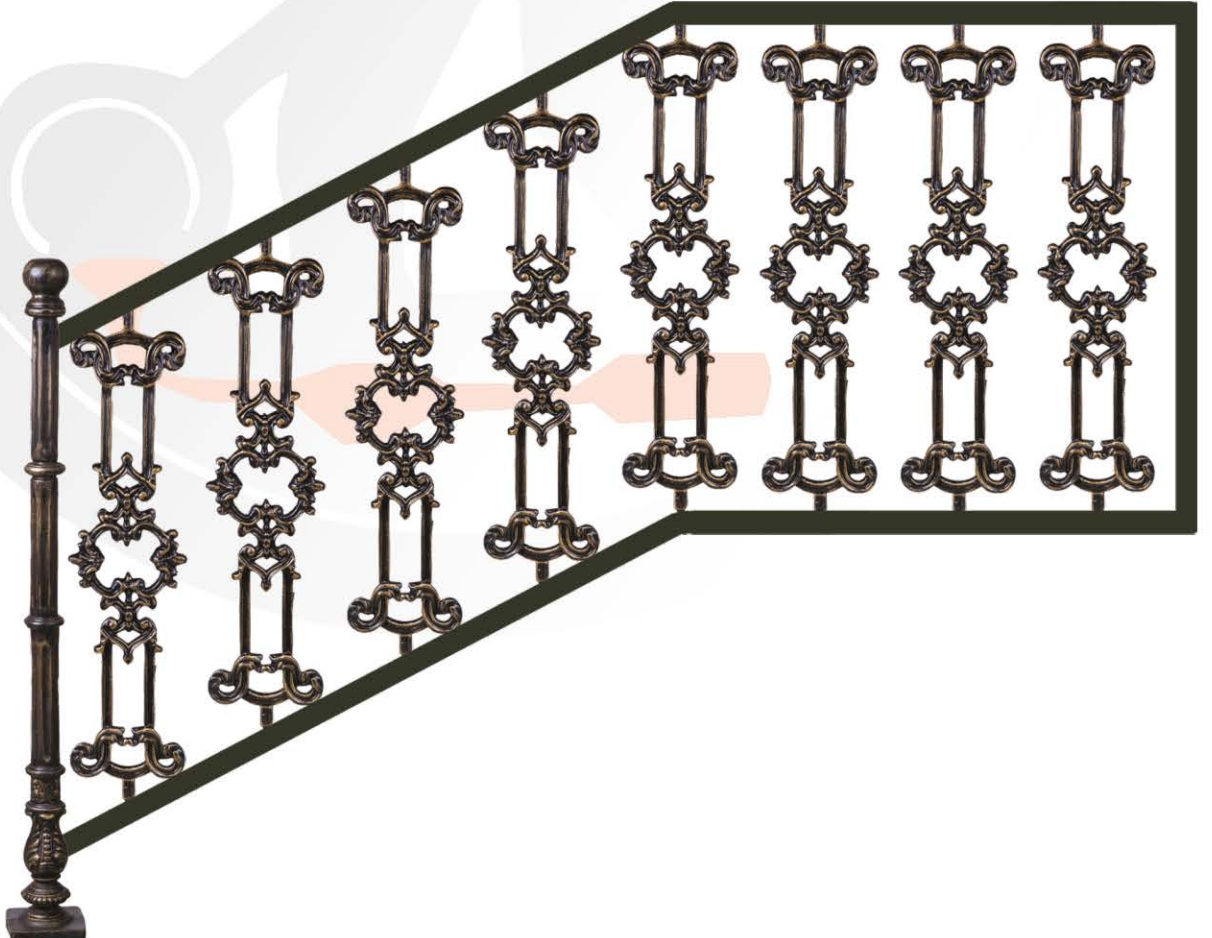

* Tüm Korkuluklar Üzerindeki Demir Pimleri Vasıtasıyla, Kaynak Yapılabilir. / * All The Steel Bolts On The Railings Permit Welding.



Malzeme : Alüminyum Döküm veya Pik Döküm yapılıdır.
Boya&Renk: Boyasız (isteğe göre boyanır)
Bazı ürün ölçüleri yazım hatasından dolayı farklı olabilir.

Material : Aluminum Cast & Cast Iron
Paint &Colours: Unpainted (painting depending on request)
The measurements of some of the products can vary due to writing errors

KORKULUK MODELLERİ



19 cm

K-153

83 cm



7 cm

K-154

79 cm



16 cm

K-155

80 cm



23 cm

K-156

85 cm



16 cm

K-157

83 cm



* Tüm Korkuluklar Üzerindeki Demir Pimleri Vasıtasıyla, Kaynak Yapılabilir. / * All The Steel Bolts On The Railings Permit Welding.



Malzeme : Alüminyum Döküm veya Pük Döküm yapılıdır.
Boya&Renk: Boyasız (isteğe göre boyanır)
Bazı ürün ölçüleri yazım hatasından dolayı farklı olabilir.

Material : Aluminum Cast & Cast Iron
Paint & Colours: Unpainted (painting depending on request)
The measurements of some of the products can vary due to writing errors

KORKULUK MODELLERİ



98 cm

23 cm

K-158

K-158-A= 81 * 23 cm



84 cm

15 cm

K-159



81 cm

15 cm

K-160



60 cm

15 cm

K-161



* Tüm Korkuluklar Üzerindeki Demir Pimleri Vasıtasıyla, Kaynak Yapılabilir. / * All The Steel Bolts On The Railings Permit Welding.



Malzeme : Alüminyum Döküm veya Pik Döküm yapılıdır.
Boya&Renk: Boyasız (isteğe göre boyanır)
Bazı ürün ölçüleri yazım hatasından dolayı farklı olabilir.

Material : Aluminum Cast & Cast Iron
Paint & Colours: Unpainted (painting depending on request)
The measurements of some of the products can vary due to writing errors

KORKULUK MODELLERİ



81 cm

18 cm

K-163



58 cm

18 cm

K-164



81 cm

18 cm

K-165



60 cm

17 cm

K-166



* Tüm Korkuluklar Üzerindeki Demir Pimleri Vasıtasıyla, Kaynak Yapılabilir. / * All The Steel Bolts On The Railings Permit Welding.



Malzeme : Alüminyum Döküm veya Pik Döküm yapılıdır.
Boya&Renk: Boyasız (isteğe göre boyanır)
Bazı ürün ölçüleri yazım hatasından dolayı farklı olabilir.

Material : Aluminum Cast & Cast Iron
Paint &Colours: Unpainted (painting depending on request)
The measurements of some of the products can vary due to writing errors

KORKULUK MODELLERİ

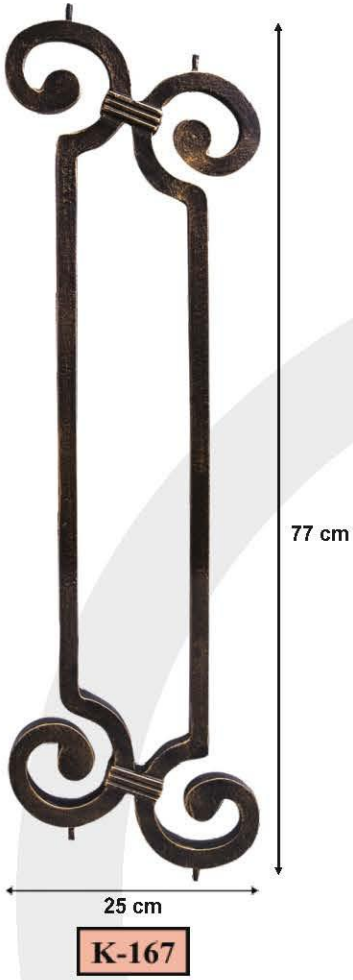

* Tüm Korkuluklar Üzerindeki Demir Pimleri Vasıtasıyla, Kaynak Yapılabilir. / * All The Steel Bolts On The Railings Permit Welding.



Malzeme : Alüminyum Döküm veya Pik Döküm yapılır.
Boya&Renk: Boyasız (isteğe göre boyanır)
Bazı ürün ölçüleri yazım hatasından dolayı farklı olabilir.

Material : Aluminum Cast & Cast Iron
Paint & Colours: Unpainted (painting depending on request)
The measurements of some of the products can vary due to writing errors

KORKULUK MODELLERİ



27 cm

K-174

76 cm



24 cm

K-175

69 cm



28 cm

K-172

81 cm



30 cm

K-177

78 cm



* Tüm Korkuluklar Üzerindeki Demir Pimleri Vasıtasıyla, Kaynak Yapılabilir. / * All The Steel Bolts On The Railings Permit Welding.



Malzeme : Alüminyum Döküm veya Pik Döküm yapılır.
Boya&Renk: Boyasız (isteğe göre boyanır)
Bazı ürün ölçüleri yazım hatasından dolayı farklı olabilir.

Material : Aluminum Cast & Cast Iron
Paint &Colours: Unpainted (painting depending on request)
The measurements of some of the products can vary due to writing errors

KORKULUK MODELLERİ

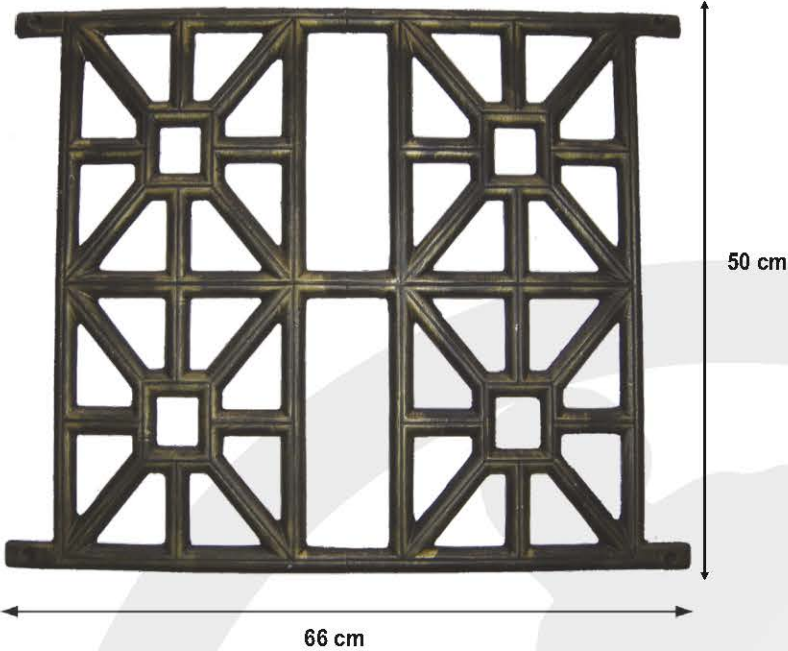

66 cm

K-185



21 cm

K-180



25 cm

K-181



* Tüm Korkuluklar Üzerindeki Demir Pimleri Vasıtasıyla, Kaynak Yapılabilir. / * All The Steel Bolts On The Railings Permit Welding.



Malzeme : Alüminyum Döküm veya Pik Döküm yapılıdır.
Boya&Renk: Boyasız (isteğe göre boyanır)
Bazı ürün ölçüleri yazım hatasından dolayı farklı olabilir.

Material : Aluminum Cast & Cast Iron
Paint & Colours: Unpainted (painting depending on request)
The measurements of some of the products can vary due to writing errors

KORKULUK MODELLERİ



28 cm

K-187



25 cm

K-188



27 cm

K-189



* Tüm Korkuluklar Üzerindeki Demir Pimleri Vasıtasıyla, Kaynak Yapılabilir. / * All The Steel Bolts On The Railings Permit Welding.



Malzeme : Alüminyum Döküm veya Pik Döküm yapılıdır.
Boya&Renk: Boyasız (isteğe göre boyanır)
Bazı ürün ölçüleri yazım hatasından dolayı farklı olabilir.

Material : Aluminum Cast & Cast Iron
Paint & Colours: Unpainted (painting depending on request)
The measurements of some of the products can vary due to writing errors

PROJE UYGULAMA KORKULUK MODELLERİ



PROJE UYGULAMA 1

*İstanbul - Wyndham Grand İstanbul Kalamış Marina Hotel Uygulaması (Tasarım Ödüllü)



PROJE UYGULAMA 1



PROJE UYGULAMA 2

*İstanbul - Kemerburgaz - Şahinler Tekstil - Villa Duvar Üstü ve Fransız Balkon Uygulaması



PROJE UYGULAMA 2



PROJE UYGULAMA 3

*İstanbul - Şişli Fransız Balkon Apartman Uygulaması



PROJE UYGULAMA 3

* Proje Korkuluk Modellerimiz Adet Olarak Verilmemektedir. / * Our Project Railing Models Are Not Given In Quantities.



Malzeme : Alüminyum Döküm veya PİK Döküm yapılıdır.
Boya&Renk: isteğe göre boyanır.
Ürünlerin Yerine Montajı, Tarafımızdan Yapılır.

Material : Aluminum Cast & Cast Iron
Paint &Colours: Painted in any color.

PROJE UYGULAMA KORKULUK MODELLERİ



PROJE UYGULAMA 4

*İstanbul - Sabiha Gökçen - Delmar Rezidans Uygulaması (Tasarım Ödüllü)



PROJE UYGULAMA 4

*İstanbul - Gürpınar - Gül İnşaat - Kavaklı Konakları Korkuluk Uygulaması



PROJE UYGULAMA 5

*Düzce - Akçakoca - Köprü Uygulaması (Tasarım Ödüllü)



PROJE UYGULAMA 6

*Kocaeli - Luxor Garden Hotel Uygulaması (Tasarım Ödüllü)

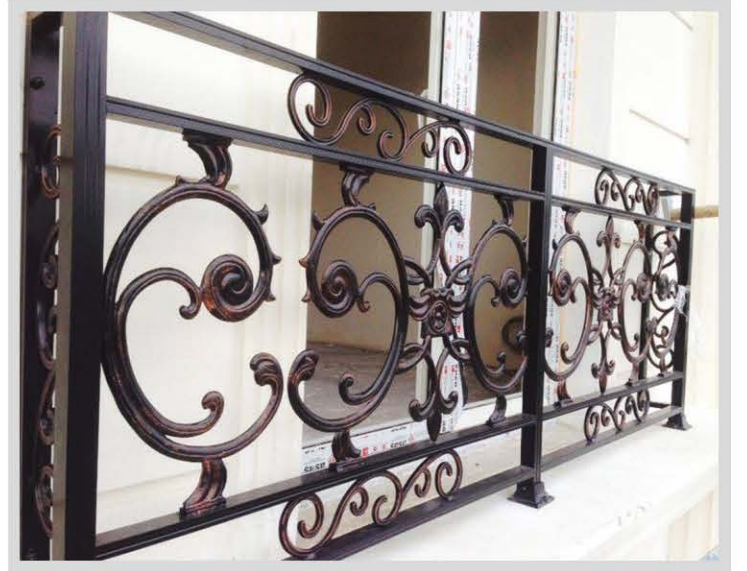

PROJE UYGULAMA 6

* Proje Korkuluk Modellerimiz Adet Olarak Verilmemektedir. / * Our Project Railing Models Are Not Given In Quantities.



Malzeme : Alüminyum Döküm veya Pik Döküm yapılır.
Boya&Renk: isteğe göre boyanır.
Ürünlerin Yerine Montajı, Tarafımızdan Yapılır.

Material : Aluminum Cast & Cast Iron
Paint &Colours: Painted in any color.

PROJE UYGULAMA KORKULUK MODELLERİ



PROJE UYGULAMA 7



PROJE UYGULAMA 7

*İstanbul - Taksim - Fransız Balkon Apartman Uygulaması



PROJE UYGULAMA 8



PROJE UYGULAMA 8

*İstanbul - Ataköy - Gül İnşaat - 7 Kısım - Fransız Balkon ve Duvar Üstü Uygulaması

* Proje Korkuluk Modellerimiz Adet Olarak Verilmemektedir. / * Our Project Railing Models Are Not Given In Quantities.



Malzeme : Alüminyum Döküm veya PİK Döküm yapılıdır.
Boya&Renk: isteğe göre boyanır.
Ürünlerin Yerine Montajı, Tarafımızdan Yapılır.

Material : Aluminum Cast & Cast Iron
Paint &Colours: Painted in any color.

PROJE UYGULAMA KORKULUK MODELLERİ



PROJE UYGULAMA 9

*İstanbul - Kandilli - Yalı - Fransız Balkon Uygulaması



PROJE UYGULAMA 9

*Antalya- Manavgat Bahçe Duvarı ve Fransız Balkon Uygulaması

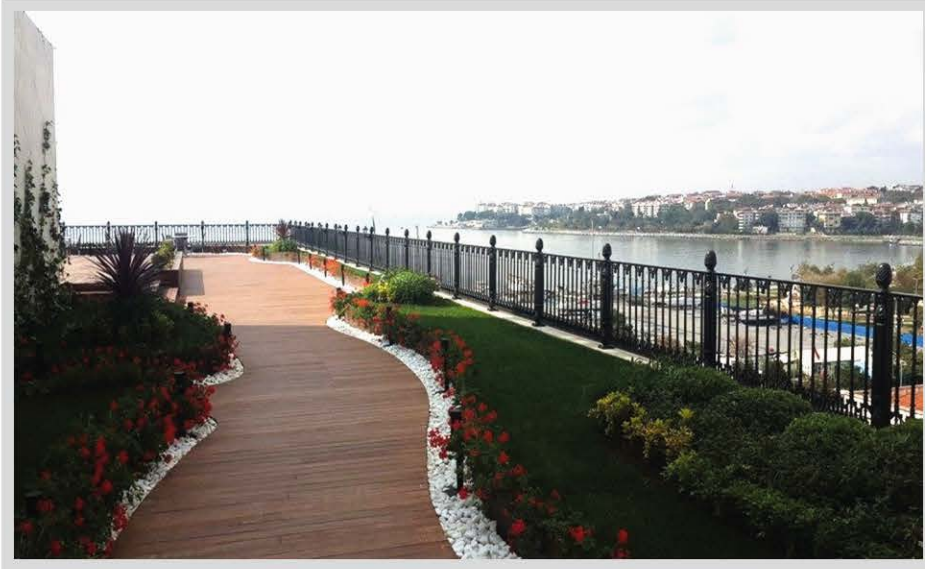

PROJE UYGULAMA 10

*İstanbul - Wyndham Grand İstanbul Kalamış Marina Hotel Uygulaması (Tasarım Ödüllü)



PROJE UYGULAMA 10

*İstanbul - Altunizade - Asya Ramada Hotel - Fransız Balkon Uygulaması



PROJE UYGULAMA 11

*İstanbul - Beylikdüzü - Perla Vista AVM Korkuluk Uygulaması

* Proje Korkuluk Modellerimiz Adet Olarak Verilmemektedir. / * Our Project Railing Models Are Not Given In Quantities.



Malzeme : Alüminyum Döküm veya Pik Döküm yapılır.
Boya&Renk: isteğe göre boyanır.
Ürünlerin Yerine Montajı, Tarafımızdan Yapılır.

Material : Aluminum Cast & Cast Iron
Paint & Colours: Painted in any color.

PROJE UYGULAMA KORKULUK MODELLERİ



PROJE UYGULAMA 12

*İstanbul - Bebek - Ramsey - Villa Duvar Üstü Korkuluk Uygulaması

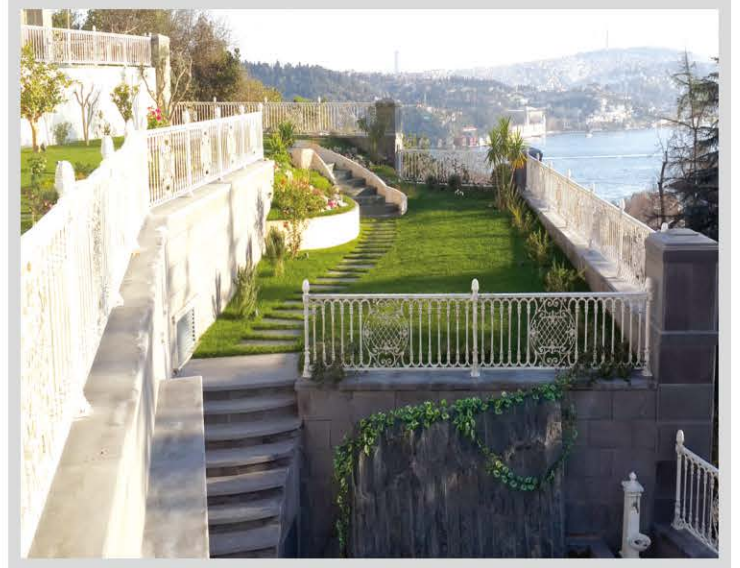

PROJE UYGULAMA 12

*İstanbul - Bebek - Ramsey - Villa Duvar Üstü Korkuluk Uygulaması



PROJE UYGULAMA 13

*İstanbul - Erenköy - Rezidans Duvar Üstü Korkuluk Uygulaması



PROJE UYGULAMA 14

*İstanbul - Büyükkada - Villa Duvar Üstü Korkuluk Uygulaması

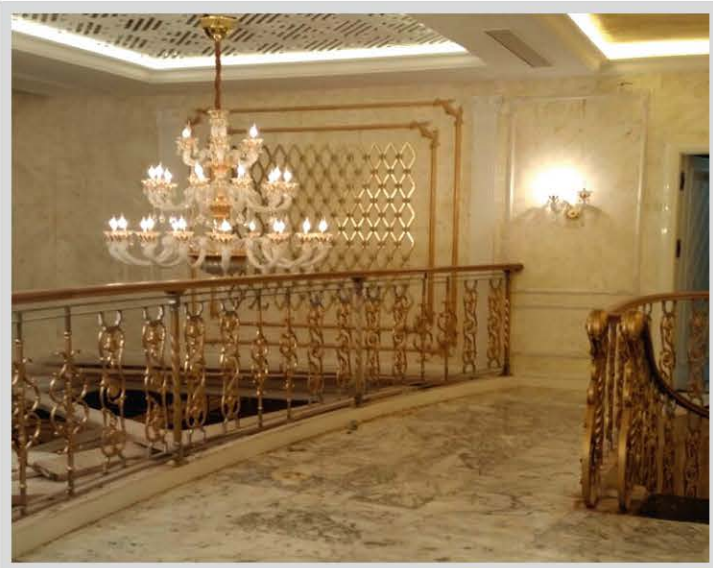

PROJE UYGULAMA 15

*İstanbul - Ataköy - Hyatt Hotel Rezidans - Merdiven Korkuluk Uygulaması



PROJE UYGULAMA 16

* Proje Korkuluk Modellerimiz Adet Olarak Verilmemektedir. / * Our Project Railing Models Are Not Given In Quantities.



Malzeme : Alüminyum Döküm veya Pik Döküm yapılır.
Boya&Renk: isteğe göre boyanır.
Ürünlerin Yerine Montajı, Tarafımızdan Yapılır.

Material : Aluminum Cast & Cast Iron
Paint &Colours: Painted in any color.

BABA MODELLERİ



25 cm

B-100



12 cm

B-101



8 cm

B-102



14 cm

B-103



14 cm

B-104



14 cm

B-105



12 cm

B-106



31 cm

B-107



13 cm

B-108



13 cm

B-109



Malzeme : Alüminyum Döküm veya Pik Döküm yapılıdır.
Boya&Renk: Boyasız (isteğe göre boyanır)
Bazı ürün ölçüleri yazım hatasından dolayı farklı olabilir.

Material : Aluminum Cast & Cast Iron
Paint &Colours: Unpainted (painting depending on request)
The measurements of some of the products can vary due to writing errors

BABA MODELLERİ



B-116



B-117



B-118

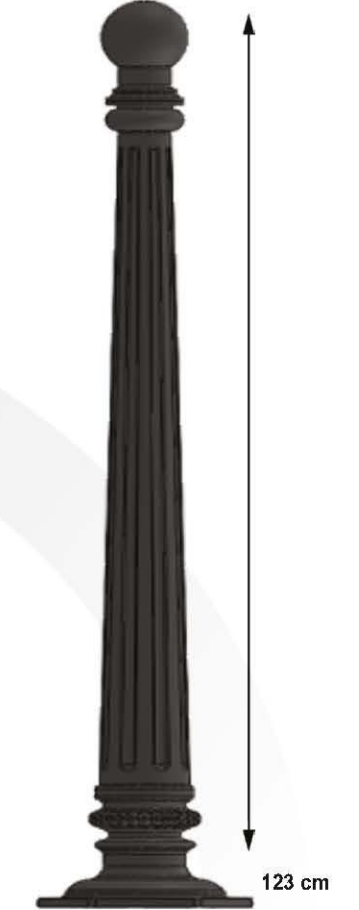

B-119



B-120



B-121



B-111



B-110



Malzeme : Alüminyum Döküm veya Pik Döküm yapılıdır.
Boya&Renk: Boyasız (isteğe göre boyanır)
Bazı ürün ölçüleri yazım hatasından dolayı farklı olabilir.

Material : Aluminum Cast & Cast Iron
Paint & Colours: Unpainted (painting depending on request)
The measurements of some of the products can vary due to writing errors

BABA ve ÇÖP KOVASI MODELLERİ



B-113



B-114



B-112



AS-114



AS-115



Malzeme : Alüminyum Döküm veya Pik Döküm yapılır.
Boya&Renk: Boyasız (isteğe göre boyanır)
Bazı ürün ölçüleri yazım hatasından dolayı farklı olabilir.

Material : Aluminum Cast & Cast Iron
Paint & Colours: Unpainted (painting depending on request)
The measurements of some of the products can vary due to writing errors

TOPUZ MODELLERİ



T-100

190 * 120 mm



T-101

80 * 80 mm

T-101-A= 100 * 100 mm
T-101-B= 60 * 60 mm



150 * 35 mm

T-104



T-102

90 * 60 mm



T-103

70 * 90 mm



T-105

180 * 140 mm



T-106

50*50- 100 * 140 mm



T-107

70 * 40 mm



T-108

T-108-A= 30 * 30 mm
T-108-B= 40 * 40 mm
T-108-C= 50 * 50 mm
T-108-D= 60 * 60 mm



T-109

T-109-A= 30 * 30 mm
T-109-B= 40 * 40 mm
T-109-C= 50 * 50 mm
T-109-D= 60 * 60 mm



T-110

90 * 60 mm
T-110-A= 30 * 30 mm
T-110-B= 40 * 40 mm



T-111

70 * 40 mm



T-112

130 * 80 mm



Malzeme : Pik Döküm (İstenirse Alüminyum Döküm yapılır.)
T-110 \ T-101 \ T- 108 \ T-109 = Profile Geçmeli.
T-100 \ T-107 \ T- 111 = Kaynak Yapılır.
Bazı ürün ölçüleri yazım hatasından dolayı farklı olabilir.

Material : Aluminum Cast Iron & Aluminum Cast
The measurements of some of the products can vary due to writing errors

KAPI ve GÖBEK AKSESUAR MODELLERİ

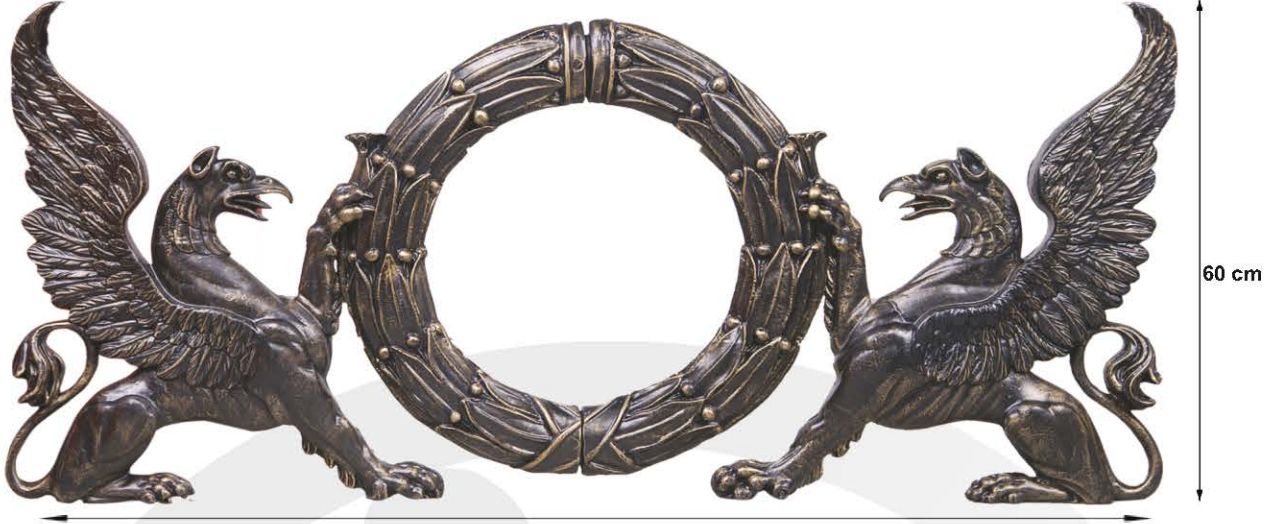

134 cm

G-100

60 cm



23 cm

42 cm

G-101



24 cm

52 cm

G-102



10 cm

32 cm

G-103



15 cm

15 cm

G-104



13 cm

34 cm

G-105



25 cm

23 cm

G-106



Malzeme: Alüminyum Döküm Veya Pik Döküm Yapılır.

Boya & Renk: Boyasız (İsteğe Göre Boyanır.)

Pik Döküm ; Paslanmaz Elektrotla Kaynatılır.

Bazı Ürünlerin Ölçüleri; Yazım Hatasından Dolayı Farklı Olabilir. 28

Material : Aluminum Cast & Cast Iron

Paint & Colours: Unpainted (Painting Depending On Request)

Cast Iron-Welding using rust resistant electrodes is possible

The measurements of some of the products can vary due to writing errors



KAPI ve GÖBEK AKSESUAR MODELLERİ

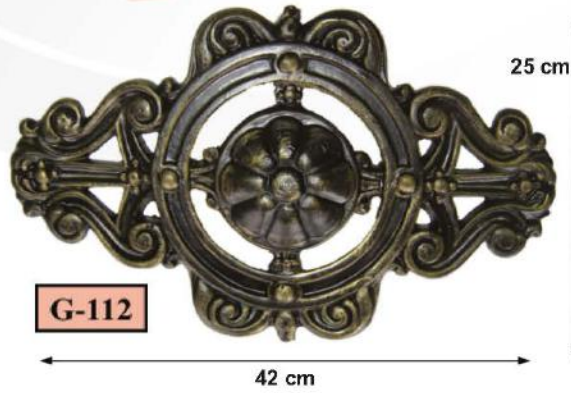
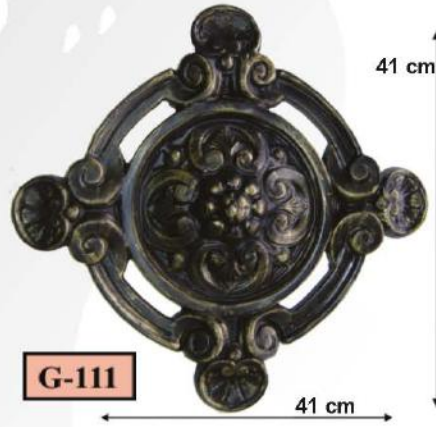

Malzeme: Alüminyum Döküm Veya Pik Döküm Yapılır.
Boya & Renk: Boyasız (İsteğe Göre Boyanır.)
Pik Döküm ; Paslanmaz Elektrotla Kaynatılır.
Bazı Ürünlerin Ölçüleri; Yazım Hatasından Dolayı Farklı Olabilir. 29

Material : Aluminum Cast & Cast Iron
Paint & Colours: Unpainted (Painting Depending On Request)
Cast Iron-Welding using rust resistant electrodes is possible
The measurements of some of the products can vary due to writing errors

KAPI ve GÖBEK AKSESUAR MODELLERİ

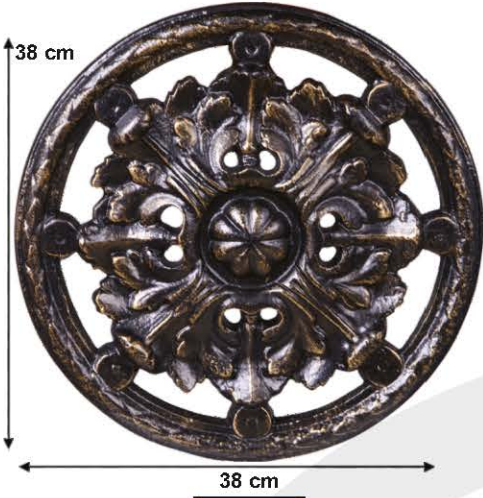

G-114



G-115



G-116



G-117



G-118

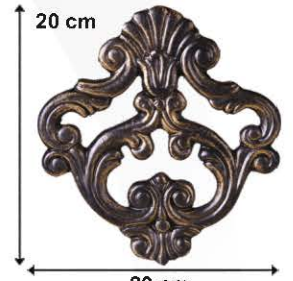

G-119

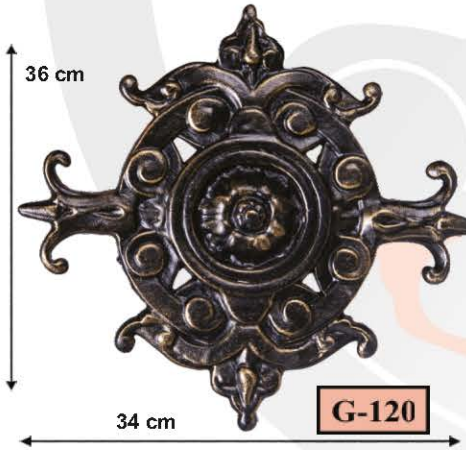

G-120



G-121

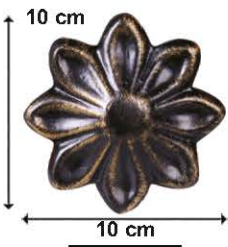

G-123

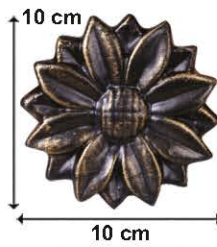

G-124

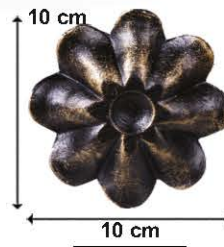

G-125



Malzeme: Alüminyum Döküm Veya Pik Döküm Yapılır.
Boya &Renk: Boyasız (İsteğe Göre Boyanır.)
Pik Döküm ; Paslanmaz Elektrotla Kaynatılır.
Bazı Ürünlerin Ölçüleri; Yazım Hatasından Dolayı Farklı Olabilir. 30

Material : Aluminum Cast & Cast Iron
Paint &Colours: Unpainted (Painting Depending On Request)
Cast Iron-Welding using rust resistant electrodes is possible
The measurements of some of the products can vary due to writing errors



KAPI ve GÖBEK AKSESUAR MODELLERİ



G-126



G-127

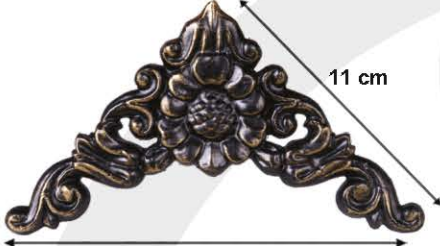

G-128



G-129



G-132



G-131

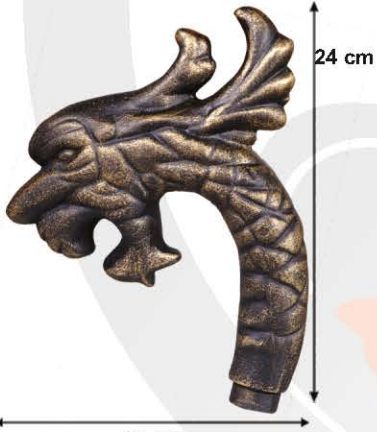

G-161



G-122



G-135



G-136

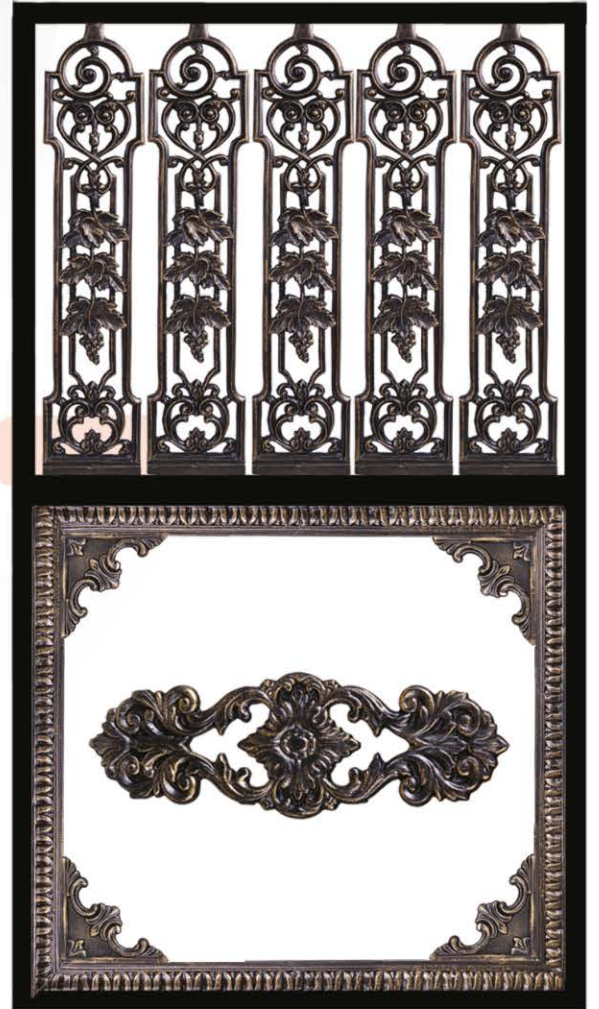

Malzeme: Alüminyum Döküm Veya Pik Döküm Yapılır.
Boya & Renk: Boyasız (İsteğe Göre Boyanır.)
Pik Döküm ; Paslanmaz Elektrotla Kaynatılır.
Bazı Ürünlerin Ölçüleri; Yazım Hatasından Dolayı Farklı Olabilir. 31

Material : Aluminum Cast & Cast Iron
Paint & Colours: Unpainted (Painting Depending On Request)
Cast Iron-Welding using rust resistant electrodes is possible
The measurements of some of the products can vary due to writing errors



KAPI ve GÖBEK AKSESUAR MODELLERİ

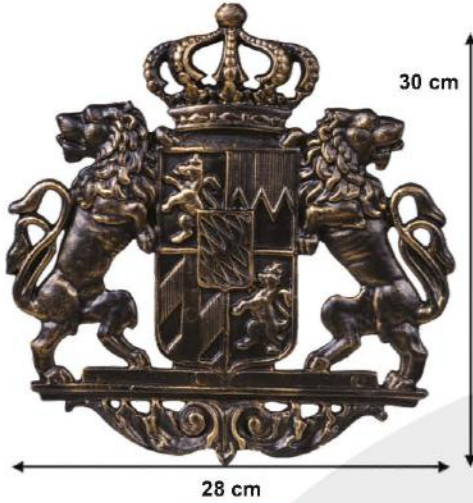

G-137



G-138



G-139



G-140



G-143



G-144

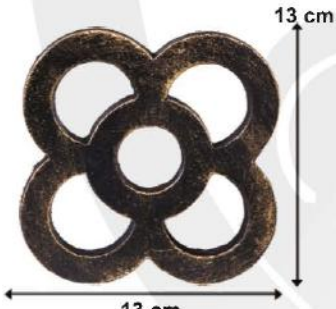

G-142

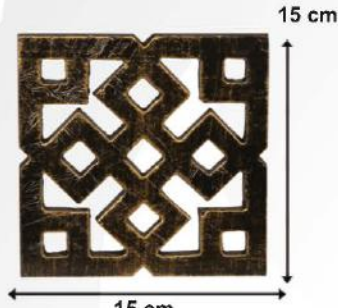

G-153



G-145



G-146



Malzeme: Alüminyum Döküm Veya Pik Döküm Yapılır.
Boya & Renk: Boyasız (İsteğe Göre Boyanır.)
Pik Döküm ; Paslanmaz Elektrotla Kaynatılır.
Bazı Ürünlerin Ölçüleri; Yazım Hatasından Dolayı Farklı Olabilir. 32

Material : Aluminum Cast & Cast Iron
Paint & Colours: Unpainted (Painting Depending On Request)
Cast Iron-Welding using rust resistant electrodes is possible
The measurements of some of the products can vary due to writing errors



KAPI ve GÖBEK AKSESUAR MODELLERİ



G-148

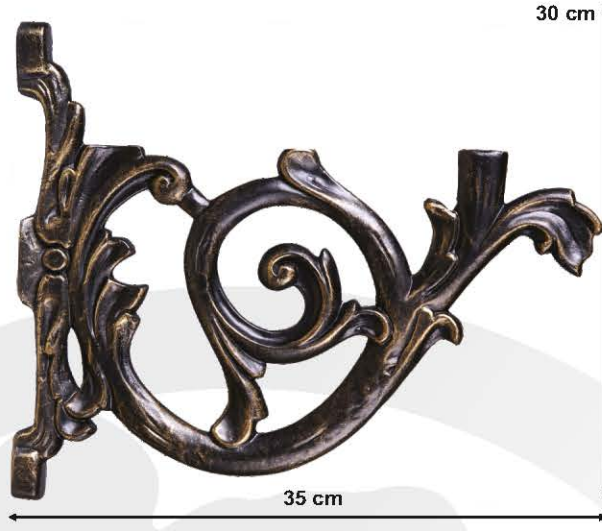

G-149



G-150

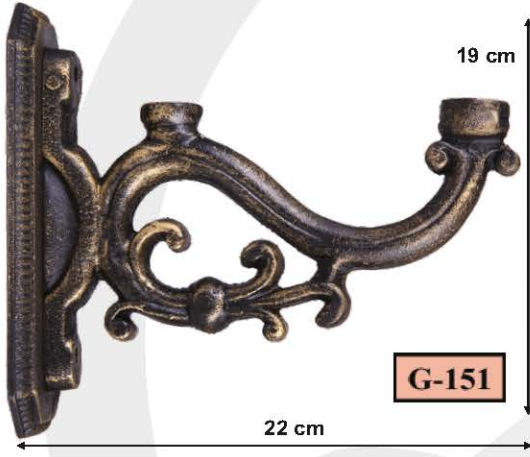

G-151



G-152



G-154



G-155

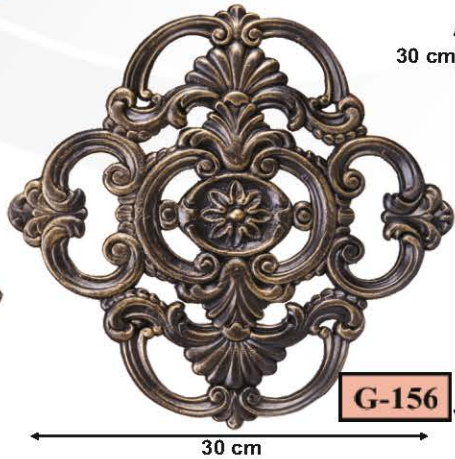

G-156



Malzeme: Alüminyum Döküm Veya Pik Döküm Yapılır.
Boya & Renk: Boyasız (İsteğe Göre Boyanır.)
Pik Döküm ; Paslanmaz Elektrotla Kaynatılır.
Bazı Ürünlerin Ölçüleri; Yazım Hatasından Dolayı Farklı Olabilir. 33

Material : Aluminum Cast & Cast Iron
Paint & Colours: Unpainted (Painting Depending On Request)
Cast Iron-Welding using rust resistant electrodes is possible
The measurements of some of the products can vary due to writing errors

KAPI ve GÖBEK AKSESUAR MODELLERİ

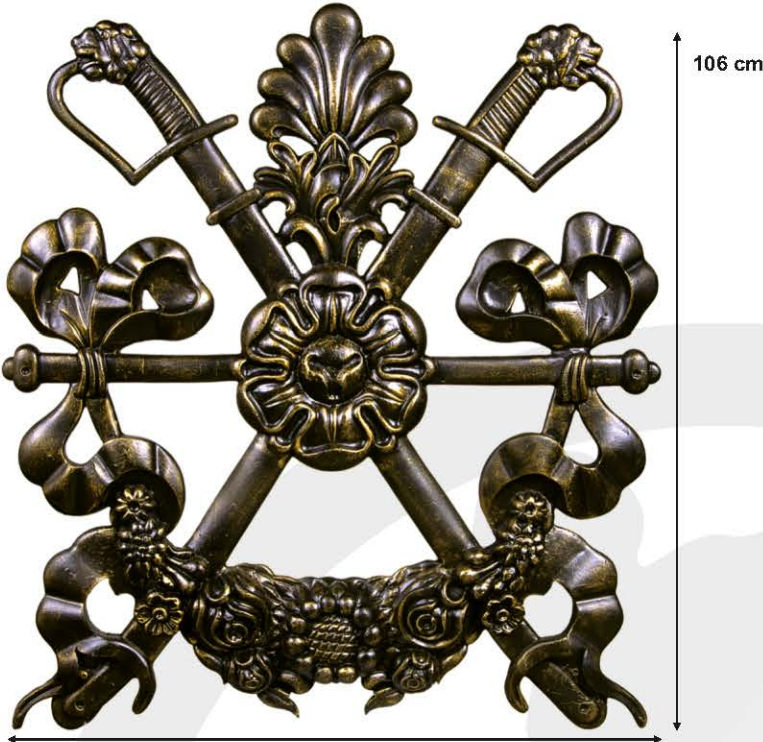

95 cm
G-157

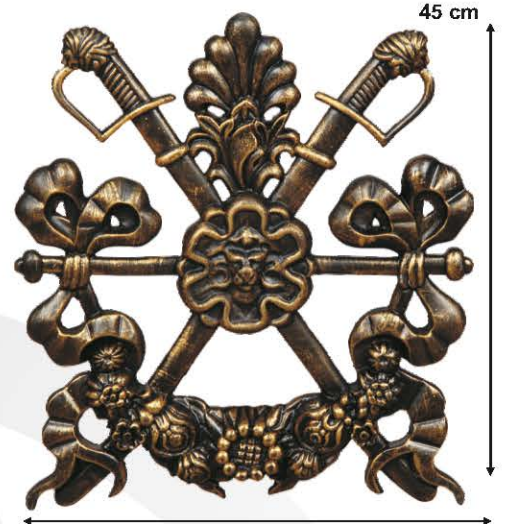

39 cm
G-158



21 cm
G-162



12 cm
G-159



14 cm
G-160



25 cm
G-165



25 cm
G-167



23.5 cm
G-168

Malzeme: Alüminyum Döküm Veya Pik Döküm Yapılır.
Boya & Renk: Boyasız (İsteğe Göre Boyanır.)
Pik Döküm ; Paslanmaz Elektrotla Kaynatılır.
Bazı Ürünlerin Ölçüleri; Yazım Hatasından Dolayı Farklı Olabilir. 34

Material : Aluminum Cast & Cast Iron
Paint & Colours: Unpainted (Painting Depending On Request)
Cast Iron-Welding using rust resistant electrodes is possible
The measurements of some of the products can vary due to writing errors



KAPI ve GÖBEK AKSESUAR MODELLERİ



100 cm

G-169

6 cm



100 cm

G-170

6 cm



100 cm

G-171

6 cm



100 cm

G-172

6 cm



100 cm

G-173

6 cm



100 cm

G-174

6 cm



100 cm

G-175

3 cm



100 cm

G-176

3 cm
4 cm
5 cm



100 cm

G-177

6 cm



Malzeme: Alüminyum Döküm Veya Pik Döküm Yapılır.
Boya &Renk: Boyasız (İsteğe Göre Boyanır.)
Pik Döküm ; Paslanmaz Elektrotla Kaynatılır.
Bazı Ürünlerin Ölçüleri; Yazım Hatasından Dolayı Farklı Olabilir. 35

Material : Aluminum Cast & Cast Iron
Paint &Colours: Unpainted (Painting Depending On Request)
Cast Iron-Welding using rust resistant electrodes is possible
The measurements of some of the products can vary due to writing errors

KAPI ve GÖBEK AKSESUAR MODELLERİ



Malzeme: Alüminyum Döküm Veya PİK Döküm Yapılır.
Boya & Renk: Boyasız (İsteğe Göre Boyanır.)
PİK Döküm ; Paslanmaz Elektrotla Kaynatılır.
Bazı Ürünlerin Ölçüleri; Yazım Hatasından Dolayı Farklı Olabilir. 36

Material : Aluminum Cast & Cast Iron
Paint & Colours: Unpainted (Painting Depending On Request)
Cast Iron-Welding using rust resistant electrodes is possible
The measurements of some of the products can vary due to writing errors

KAPI ve GÖBEK AKSESUAR MODELLERİ

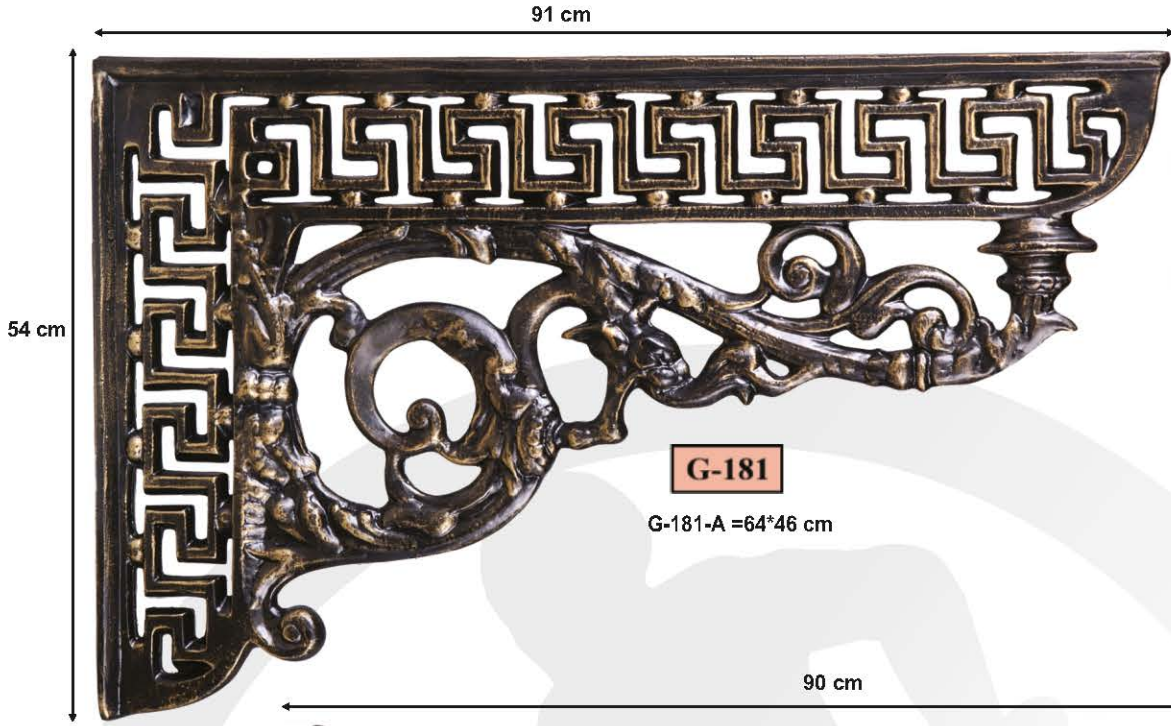

Malzeme: Alüminyum Döküm Veya Pik Döküm Yapılır.
Boya & Renk: Boyasız (İsteğe Göre Boyanır.)
Pik Döküm ; Paslanmaz Elektrotla Kaynatılır.
Bazı Ürünlerin Ölçüleri; Yazım Hatasından Dolayı Farklı Olabilir. 37

Material : Aluminum Cast & Cast Iron
Paint & Colours: Unpainted (Painting Depending On Request)
Cast Iron-Welding using rust resistant electrodes is possible
The measurements of some of the products can vary due to writing errors

KAPI ve GÖBEK AKSESUAR MODELLERİ

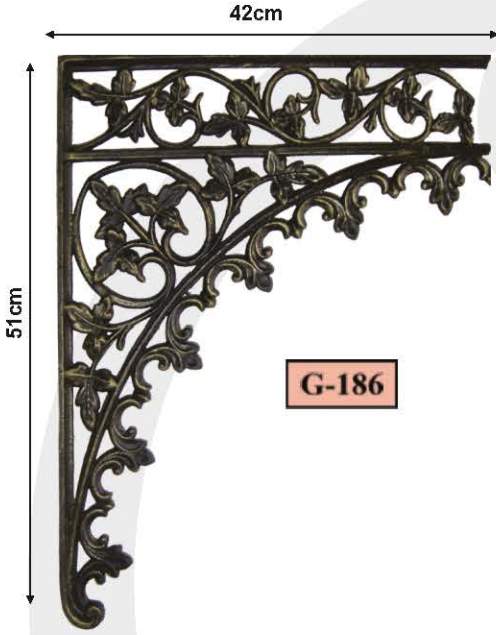
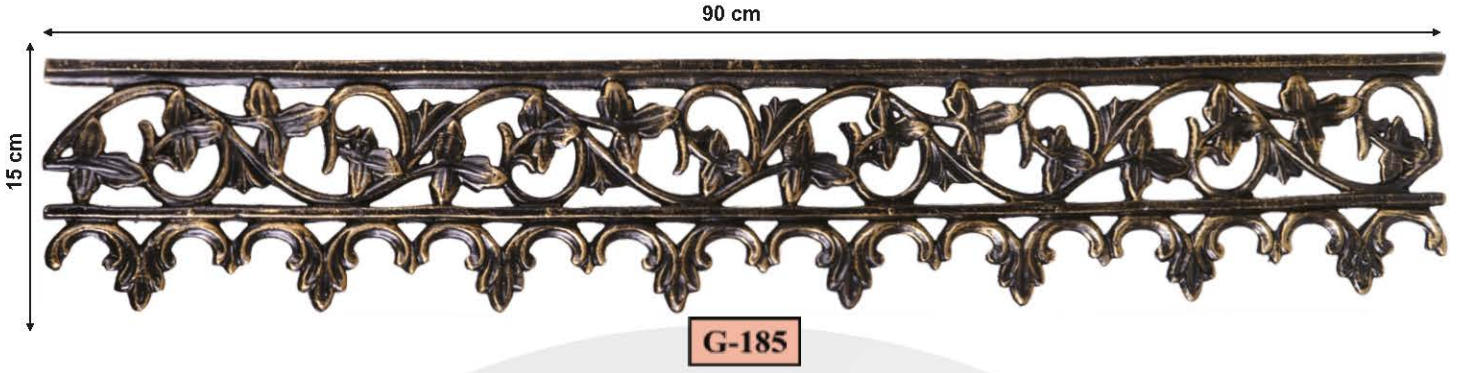

Malzeme: Alüminyum Döküm Veya Pik Döküm Yapılır.
Boya & Renk: Boyasız (İsteğe Göre Boyanır.)
Pik Döküm ; Paslanmaz Elektrotla Kaynatılır.
Bazı Ürünlerin Ölçüleri; Yazım Hatasından Dolayı Farklı Olabilir. 38

Material : Aluminum Cast & Cast Iron
Paint & Colours: Unpainted (Painting Depending On Request)
Cast Iron-Welding using rust resistant electrodes is possible
The measurements of some of the products can vary due to writing errors



OSMANLI TOPUZU (cami lokumu) MODELLERİ



C-100 35 * 35 Ø 14

C-101 35 * 35 Ø 16

C-102 40 * 40 Ø 17

C-103 45 * 45 Ø 18

C-104 45 * 45 Ø 20

C-105 50 * 50 Ø 18

C-106 50 * 50 Ø 20

C-107 60 * 60 Ø 26



C-108 35 * 35 □ 16

C-109 40 * 40 □ 17

C-110 50 * 50 □ 18



Capraz Kare

C-111 45 * 45 □ 16

C-112 45 * 45 □ 20



Malzeme : Pk Döküm
Malzeme : İsteğe göre delinir (Ø)
Bazı ürünlerin ölçüleri; yazım hatasından dolayı farklı olabilir.

Material : Cast Iron
Material : Optionally Drilled (Ø)
The measurements of some of the products can vary due to writing errors

ROZET MODELLERİ



A-100 \square 30 * 30

A-103 \square 60 * 60

A-101 \square 40 * 40

A-104 \square 80 * 80

A-102 \square 50 * 50



A-105 \square 40 * 60



A-106 \square 40 * 30



A-107 \square 20 * 10

A-110 \square 30 * 20

A-108 \square 25 * 10

A-111 \square 40 * 10

A-109 \square 30 * 10

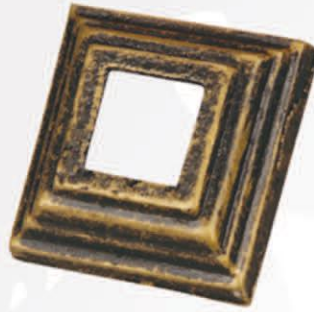

A-112 \square 12 * 12

A-113 \square 16 * 16

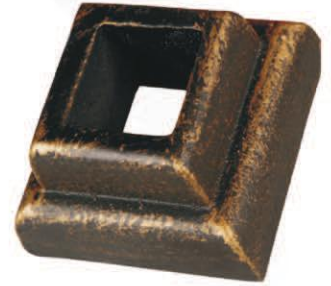

A-114 \square 25 * 25



A-115 \varnothing 20 mm \varnothing 76 mm
 \varnothing 42 mm \varnothing 89 mm
 \varnothing 48 mm \varnothing 114 mm
 \varnothing 60 mm



A-116 \varnothing 20 * 130 mm

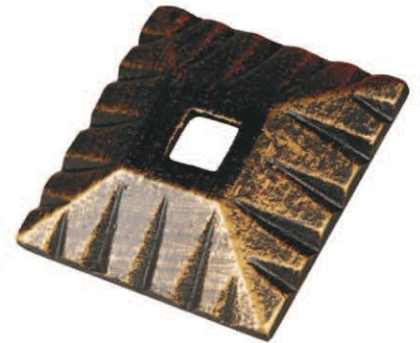

A-117 \square 16 * 190 mm



A-118 \varnothing 15 mm



A-119 \varnothing 12 * 60 mm



Malzeme : Pik Döküm (İstenirse Alüminyum Döküm yapılır.)

Bazı ürün ölçüleri yazım hatasından dolayı farklı olabilir.

Material : Aluminum Cast & Cast Iron

40 The measurements of some of the products can vary due to writing errors

ARAPARÇA MODELLERİ



65 *46 Ø 16 mm

AR-100



70 *40 Ø 16 mm

AR-101



70 *41 Ø 16 mm

AR-102



125 *46 Ø 16 mm

AR-103



130 *40 Ø 16 mm

AR-104



70 *50 Ø 16 mm

AR-105



160 *100 Ø 16 mm

AR-106



160 *100 Ø 45 mm

AR-107



130 *50 Ø 16 mm

AR-108



160 *160 Ø 16 mm

AR-109



150 *70 Ø 16 mm

AR-110



170 *100 Ø 16 mm

AR-111



Malzeme : Pik Döküm (İstenirse Alüminyum Döküm yapılır.)

Material : Aluminum Cast & Cast Iron

Bazı ürün ölçüleri yazım hatasından dolayı farklı olabilir.

The measurements of some of the products can vary due to writing errors

ARAPARÇA MODELLERİ



70 *26 mm
AR-112



60 *40Ø 25 mm
AR-113



70 *40Ø 16 mm
AR-114



100 *30 mm
AR-115



110 *40Ø 25 mm
AR-116



130 *40Ø 16 mm
AR-117



160*90 mm
AR-118



150 *60Ø 25 mm
AR-119



60 *40Ø 14 mm
AR-120



130 *30Ø 16 mm
AR-128

55 *40Ø 16 mm
AR-121



100 *40Ø 16 mm
AR-122



80 *50Ø 16 mm
AR-129



145 *45Ø 14 mm
AR-124

*AR-112 \ AR-115 \ AR-118 İçi Dolu / *AR - 112 \ AR- 115 \ AR- 118 The Inside Are Solid (Filled)



Malzeme : Pik Döküm (İstenirse Alüminyum Döküm yapılır.)

Material : Cast Iron & Aluminum Cast

Bazı ürün ölçüleri yazım hatasından dolayı farklı olabilir.

The measurements of some of the products can vary due to writing errors

MIZRAK MODELLERİ



M-100 12*9 cm



M-101 17*14 cm



M-105 20*6 cm



M-106 21*5 cm



M-104 16*6 cm



M-109 16*6 cm



M-114 23*12 cm



M-108 39*28 cm



Malzeme : Pk Döküm (İstenirse Alüminyum Döküm yapılır.)

Bazı ürün ölçüleri yazım hatasından dolayı farklı olabilir.

Material : Cast Iron & Aluminum Cast

MIZRAK MODELLERİ



M-117 28*12 cm



M-118 13*7 cm



M-119 33*9 cm



M-120 33*8 cm



M-121 40*5 cm



M-122 30*4 cm



M-123 30*4 cm



M-130 14*5 cm



M-131 14*5 cm



Malzeme : PİK Döküm (İstenirse Alüminyum Döküm yapılır.)

Bazı ürün ölçüleri yazım hatasından dolayı farklı olabilir.

Material : Cast Iron & Aluminum Cast

MIZRAK MODELLERİ



M-132 12*4 cm



M-133 18*7 cm



M-139 20*9 cm



M-147 29*10 cm



M-134 28*8 cm



M-135 27*9 cm



M-136 25*8 cm



M-137 19*6 cm



M-138 16*5 cm



M-145 20*6 cm



M-146 26*10 cm



AR-125 200*120 12 mm



Malzeme : Pk Döküm (İstenirse Alüminyum Döküm yapılır.)

Material : Cast Iron & Aluminum Cast

Bazı ürün ölçüleri yazım hatasından dolayı farklı olabilir.

The measurements of some of the products can vary due to writing errors

MASA MODELLERİ

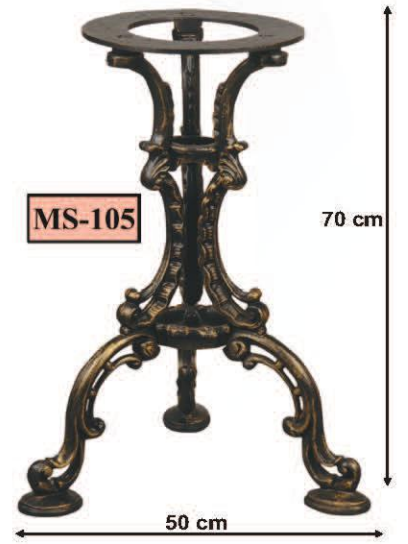
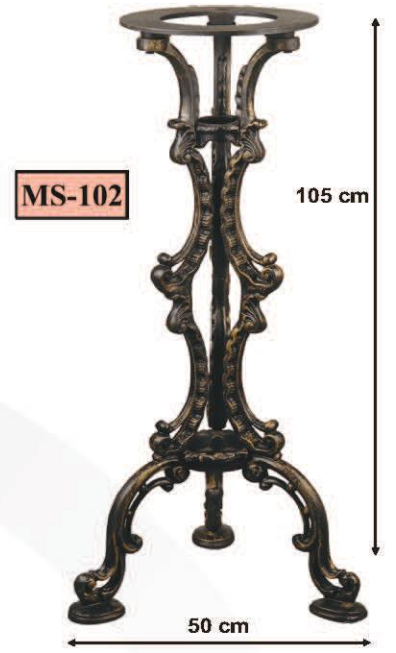

Malzeme : Pik Döküm (İstenirse Alüminyum Döküm Yapılır.
Boya & Renk: Boyasız (İsteğe Göre Boyanır.)
Bazı Ürünlerin Ölçüleri; yazım hatasından dolayı farklı olabilir.

Material : Aluminum Cast & Cast Iron
Paint & Colours: Unpainted (Painting Depending On Request)

MASA MODELLERİ

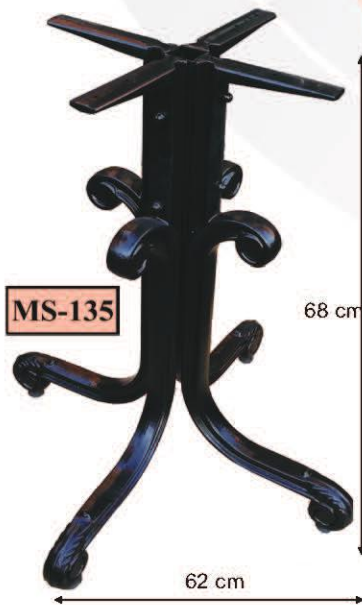
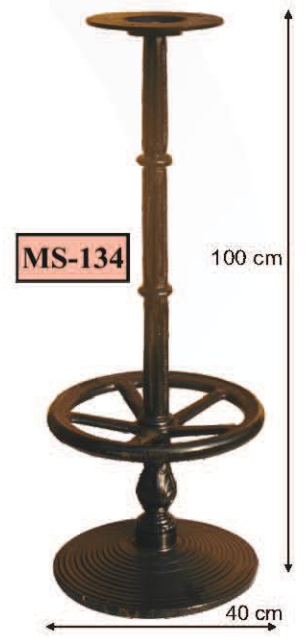

Malzeme : Pük Döküm (İstenirse Alüminyum Döküm Yapılır.
Boya & Renk: Boyasız (İsteğe Göre Boyanır.)
Başı Ürünlerin Ölçüleri; yazım hatasından dolayı farklı olabilir.

Material : Aluminum Cast & Cast Iron
Paint & Colours: Unpainted (Painting Depending On Request)

MASA MODELLERİ

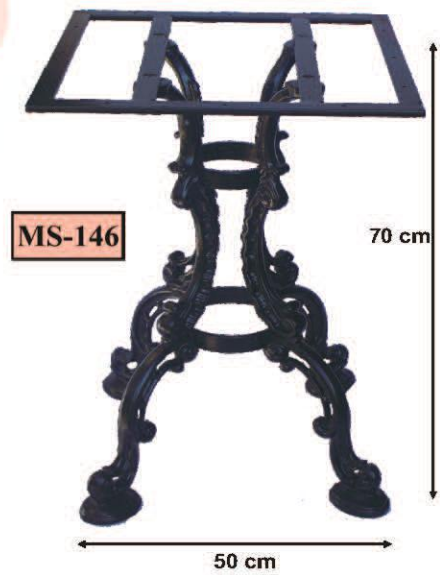
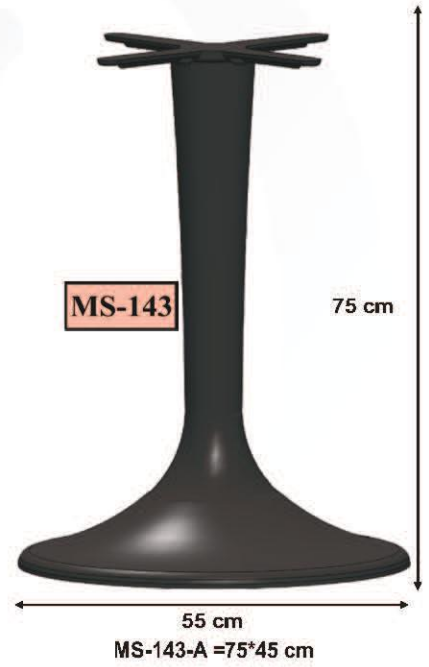
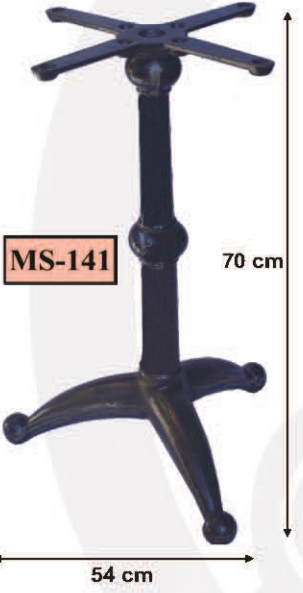
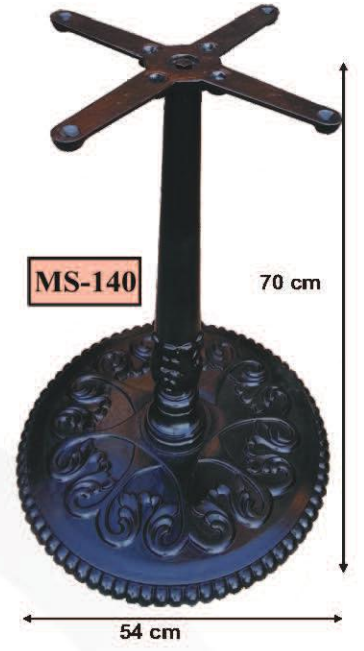
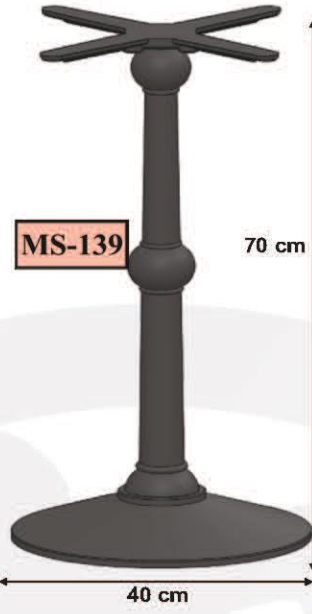
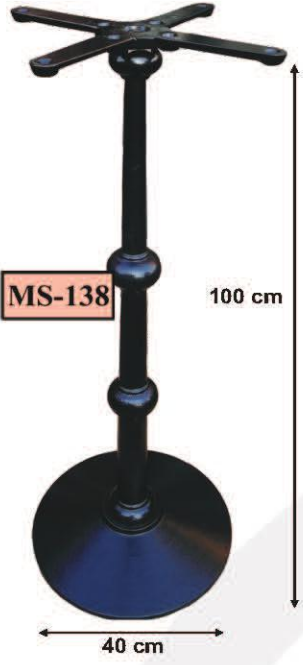

Malzeme : Pik Döküm (İstenirse Alüminyum Döküm Yapılır.
Boya & Renk: Boyasız (İsteğe Göre Boyanır.)
Bazı Ürünlerin Ölçüleri; yazım hatasından dolayı farklı olabilir.

Material : Aluminum Cast & Cast Iron
Paint & Colours: Unpainted (Painting Depending On Request)

MASA MODELLERİ



Malzeme : Pik Döküm (İstenirse Alüminyum Döküm Yapılır.
Boya & Renk: Boyasız (İsteğe Göre Boyanır.)
Bazı Ürünlerin Ölçüleri; yazım hatasından dolayı farklı olabilir.

Material : Aluminum Cast & Cast Iron
Paint & Colours: Unpainted (Painting Depending On Request)

MASA MODELLERİ



MS-116



MS-117



MS-118



MS-119



MS-120



MS-121



Malzeme : Pik Döküm (İstenirse Alüminyum Döküm Yapılır.
Boya & Renk: Boyasız (İsteğe Göre Boyanır.)
Bazı Ürünlerin Ölçüleri; yazım hatasından dolayı farklı olabilir.

Material : Aluminum Cast & Cast Iron
Paint & Colours: Unpainted (Painting Depending On Request)

MASA MODELLERİ

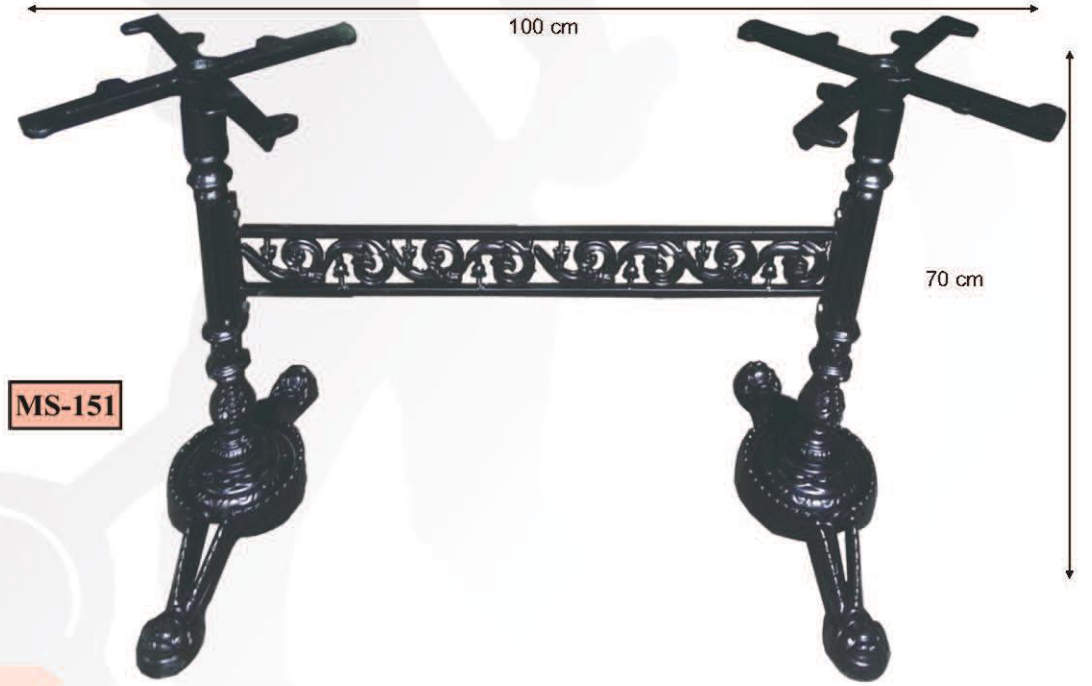

Malzeme : Pik Döküm (İstenirse Alüminyum Döküm Yapılır.
Boya & Renk: Boyasız (İsteğe Göre Boyanır.)
Bazı Ürünlerin Ölçüleri; yazım hatasından dolayı farklı olabilir.

Material : Aluminum Cast & Cast Iron
Paint & Colours: Unpainted (Painting Depending On Request)

MASA MODELLERİ



MS-153

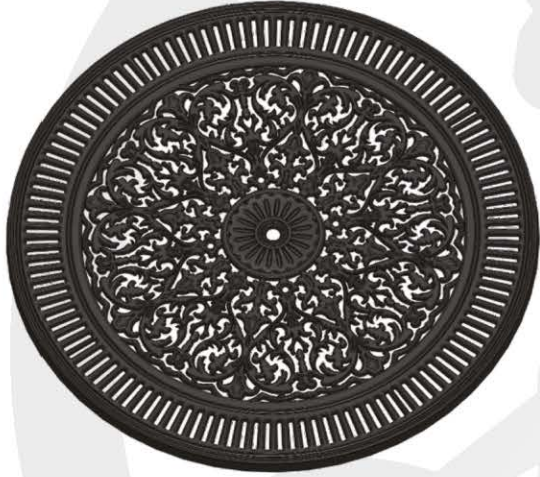

MS-154



MS-155



MS-123

Taban = 50 * 50 cm



MS-156



Malzeme : Pik Döküm (İstenirse Alüminyum Döküm Yapılır.
Boya & Renk: Boyasız (İsteğe Göre Boyanır.)
Bazı Ürünlerin Ölçüleri; yazım hatasından dolayı farklı olabilir.

Material : Aluminum Cast & Cast Iron
Paint & Colours: Unpainted (Painting Depending On Request)

MASA MODELLERİ



MS-128 Taban = 115 cm
Yükseklik= 74 cm



MS-129 Taban = 130 * 68 cm
Yükseklik= 74 cm



Malzeme: Pik Döküm veya Alüminyum Döküm Yapılır.
Boya & Renk: Boyasız (İsteğe Göre Boyanır.)
Fiyatlara Masaların Üzerindeki Cam Dahil Degildir .
Bazı Ürünlerin Ölçüleri; Yazım Hatasından Dolayı Farklı Olabilir.

Material : Cast Iron & Aluminum Cast
Paint & Colours: Unpainted (Painting Depending On Request)
The Galss On Top Of The Tables Is Not Included In The Price
The measurements of some of the products can vary due to writing errors

SANDALYE MODELLERİ



SN-100

93 cm

42 cm



SN-101

93 cm

42 cm



SN-102

85 cm

42 cm



SN-105

87 cm

42 cm



SN-106

82 cm

52 cm



SN-107

82 cm

52 cm



Malzeme: Alüminyum Döküm' den imal edilir.
Boya & Renk: Elektrostatik & Sipariş Göre.
Bazı Ürünlerin Ölçüleri; Yazım Hatasından Dolayı Farklı Olabilir.

Material : Aluminum Cast
Paint & Colours: Electrotatice & Made To Order
The measurements of some of the products can vary due to writing errors

SANDALYE AKSESUAR MODELLERİ

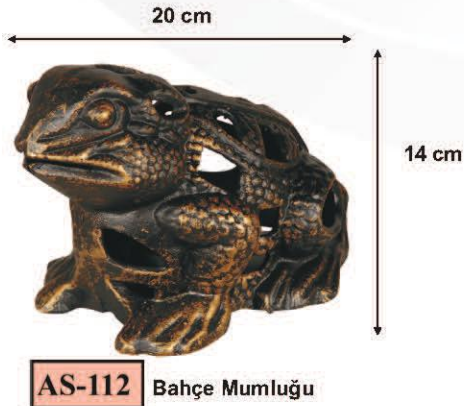
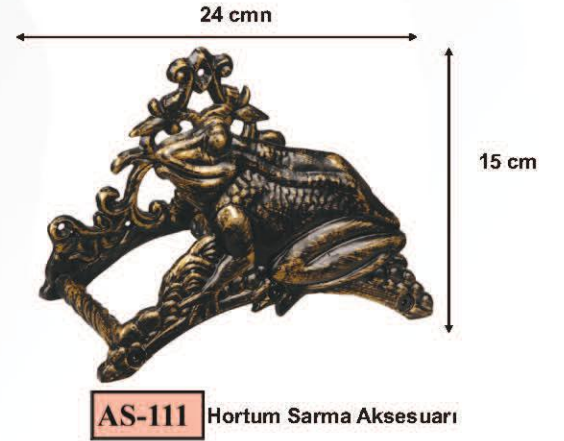

Malzeme: Alüminyum Döküm' den imal edilir.
Boya & Renk: Elektrostatik & Siparişe Göre.
Bazı Ürünlerin Ölçüleri; Yazım Hatasından Dolayı Farklı Olabilir.

Material : Aluminum Cast
Paint & Colours: Electrotatice & Made To Order
The measurements of some of the products can vary due to writing errors

ÇEŞME MODELLERİ

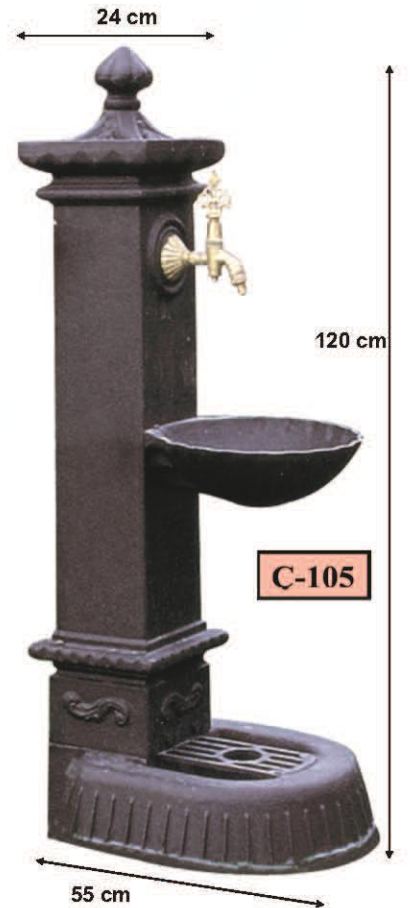
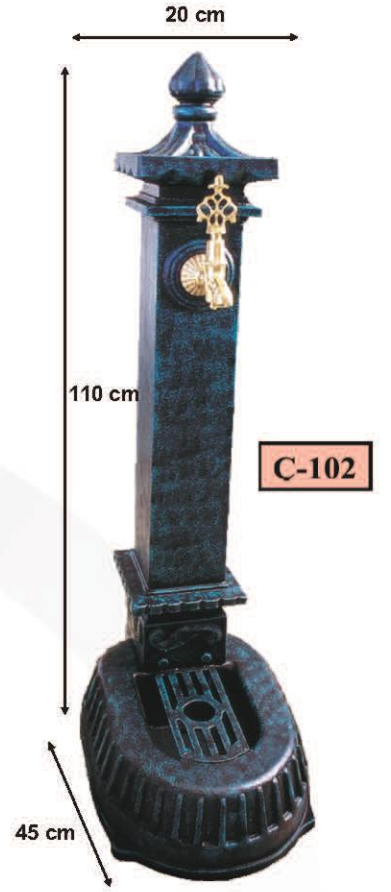
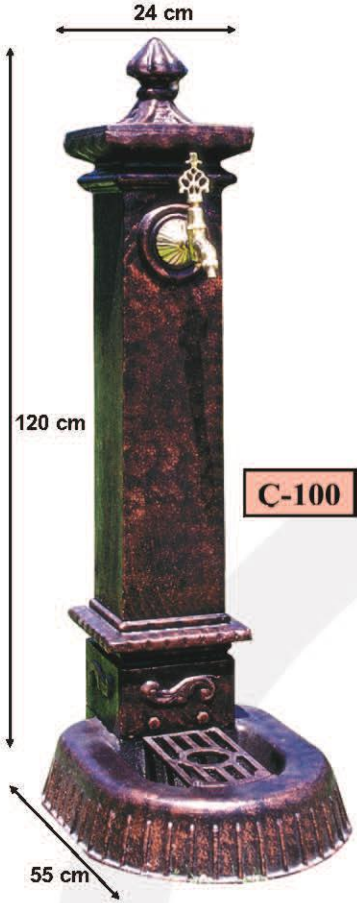

Malzeme: Pik Döküm ve Alüminyum Döküm'den imal edilir.
Boya & Renk: Elektrostatik & Siparişe Göre.
Bazı Ürünlerin Ölçüleri; Yazım Hatasından Dolayı Farklı Olabilir.

Material : Cast Iron & Aluminum Cast
Paint & Colours: Electrostatic & Made To Order
The measurements of some of the products can vary due to writing errors

ÇEŞME ve POSTA KUTUSU MODELLERİ

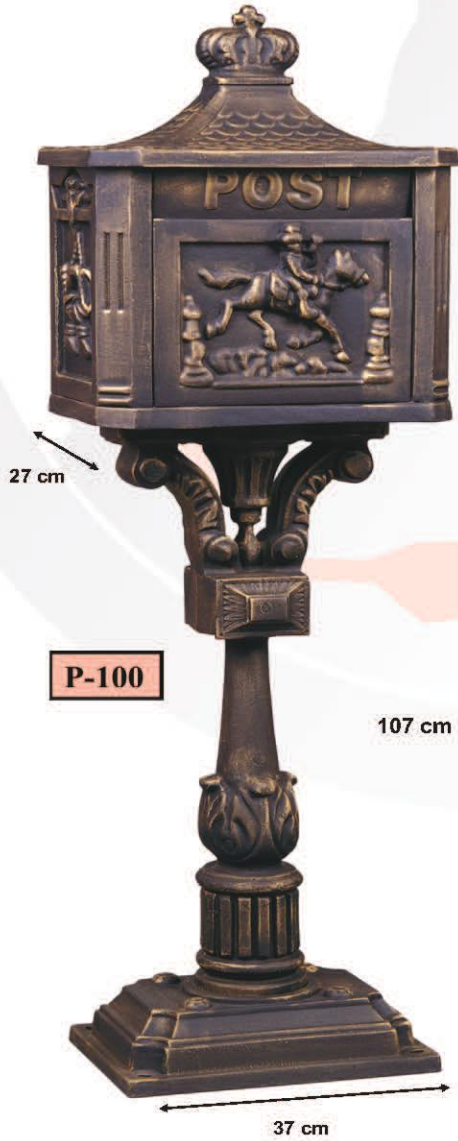

Malzeme: Pk Döküm ve Alüminyum Döküm' den imal edilir.
Boya & Renk: Elektrostatik & Siparişe Göre.
Bazı Ürünlerin Ölçüleri; Yazım Hatasından Dolayı Farklı Olabilir.

Material : Cast Iron & Aluminum Cast
Paint & Colours: Electrostatic & Made To Order
The measurements of some of the products can vary due to writing errors

POSTA KUTUSU MODELLERİ

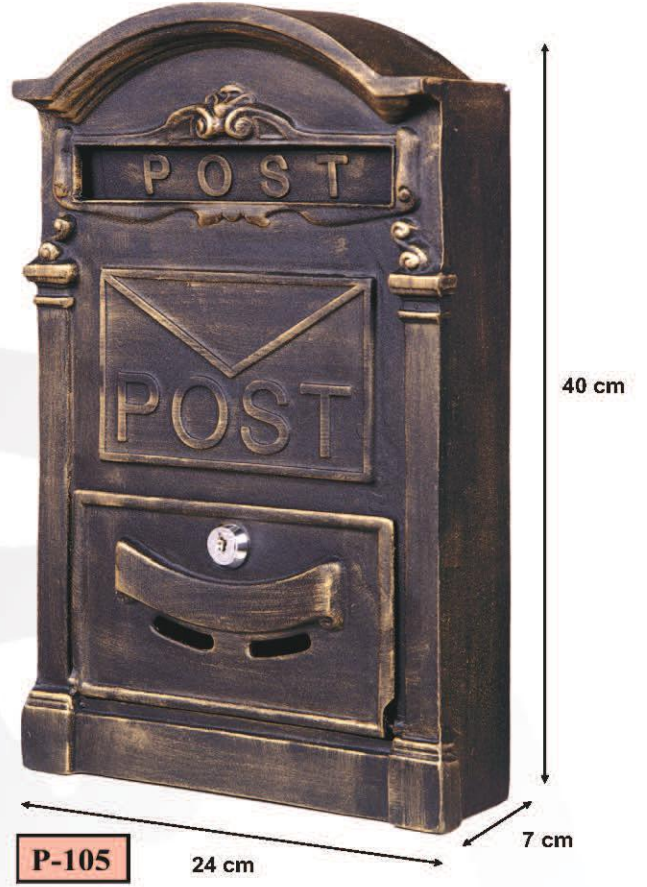
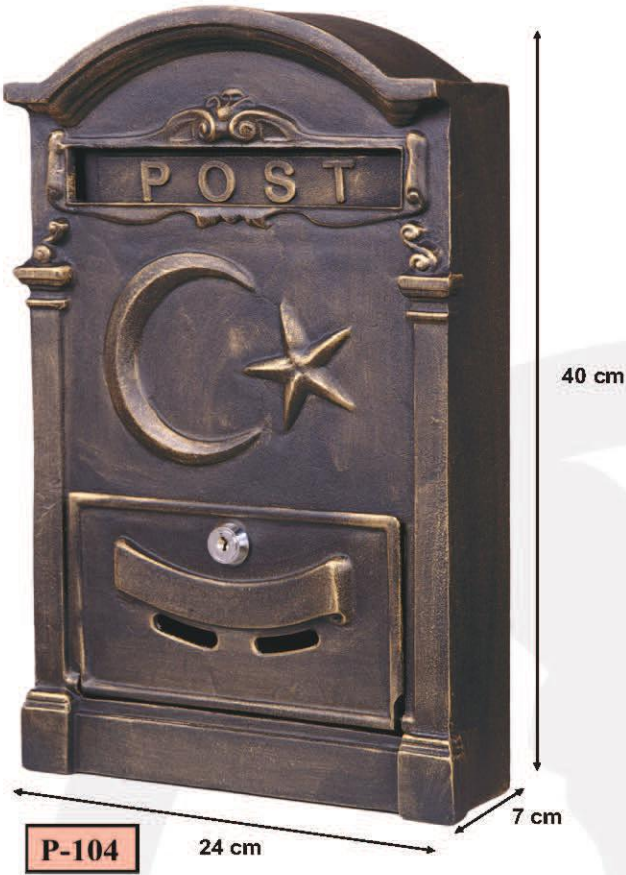

Malzeme: Alüminyum Döküm' den imal edilir.
Boya & Renk: Elektrostatik & Siparişe Göre.
Bazı Ürünlerin Ölçüleri; Yazım Hatasından Dolayı Farklı Olabilir.

Material : Aluminum Cast
Paint & Colours: Electrotatice & Made To Order
The measurements of some of the products can vary due to writing errors

BANK ve AYAK MODELLERİ

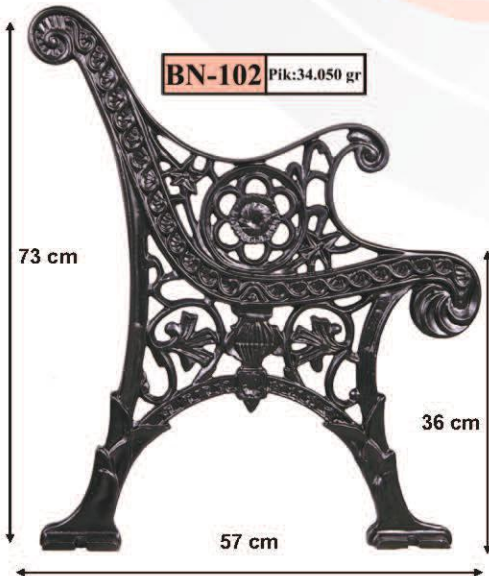
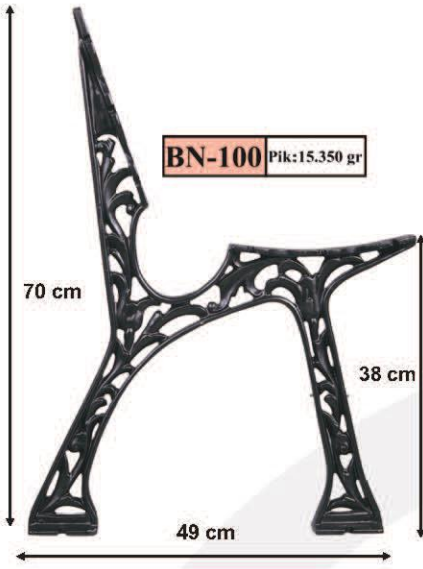

Malzeme: PİK Döküm (İstenirse Alüminyum Döküm Yapılır.)
Boya & Renk: Boyasız (İsteğe Göre Boyanır.)
Bazı Ürünlerin Ölçüleri; Yazım Hatasından Dolayı Farklı Olabilir.

Material : Cast Iron & Aluminum Cast
Paint & Colours: Unpainted (Painting Depending On Request)
The measurements of some of the products can vary due to writing errors

BANK ve AYAK MODELLERİ

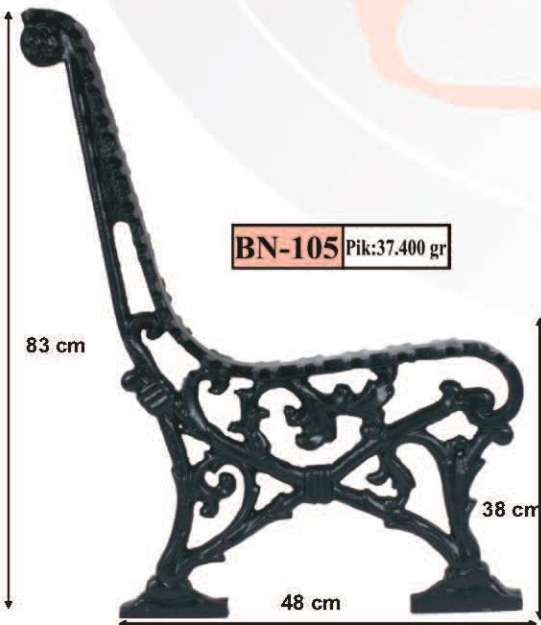
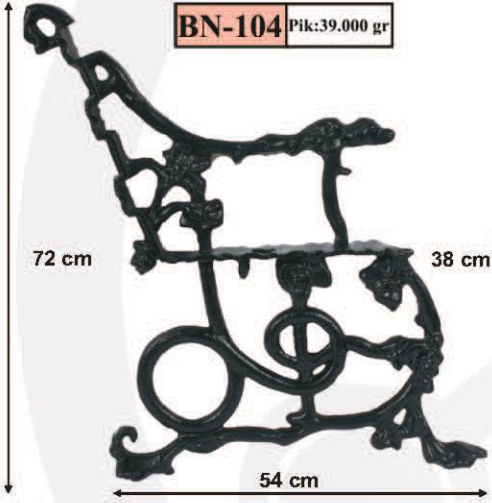
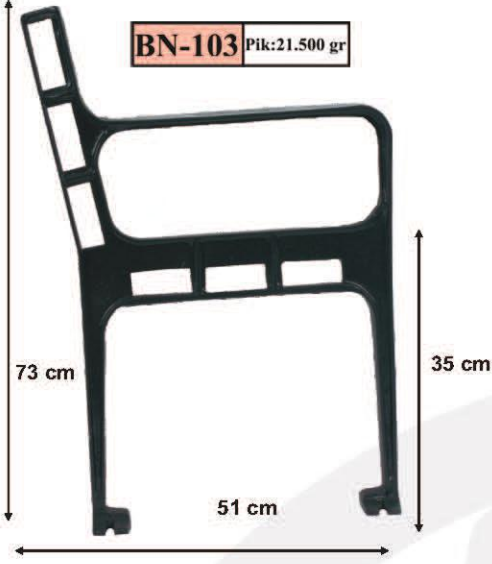

Malzeme: Pik Döküm (İstenirse Alüminyum Döküm Yapılır.)
Boya & Renk: Boyasız (İsteğe Göre Boyanır.)
Bazı Ürünlerin Ölçüleri; Yazım Hatasından Dolayı Farklı Olabilir.

Material : Cast Iron & Aluminum Cast
Paint & Colours: Unpainted (Painting Depending On Request)
The measurements of some of the products can vary due to writing errors

BANK ve AYAK MODELLERİ

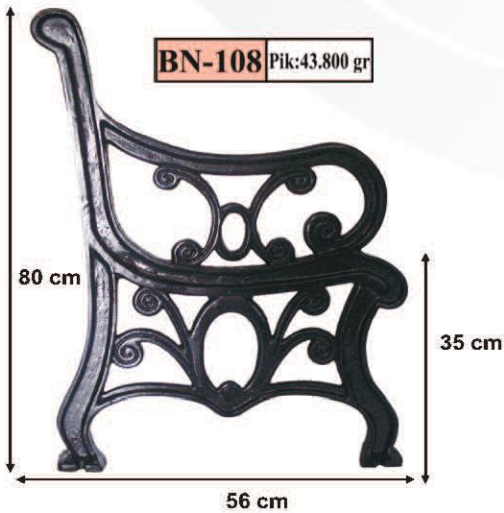

Malzeme: Pik Döküm (İstenirse Alüminyum Döküm Yapılır.)
Boya & Renk: Boyasız (İsteğe Göre Boyanır.)
Bazı Ürünlerin Ölçüleri; Yazım Hatasından Dolayı Farklı Olabilir.

Material : Cast Iron & Aluminum Cast
Paint & Colours: Unpainted (Painting Depending On Request)
The measurements of some of the products can vary due to writing errors

BANK ve AYAK MODELLERİ

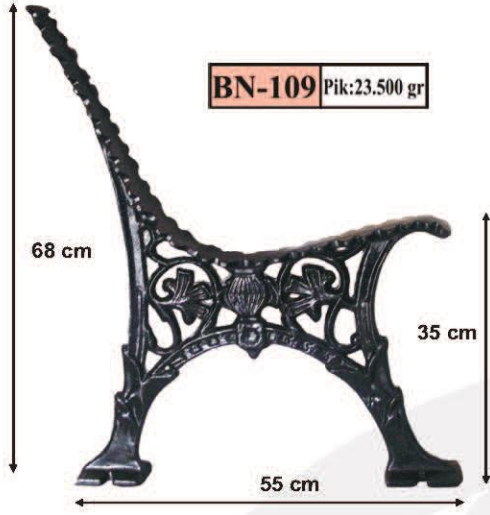

Malzeme: Pik Döküm (İstenirse Alüminyum Döküm Yapılır.)
Boya & Renk: Boyasız (İsteğe Göre Boyanır.)
Bazı Ürünlerin Ölçüleri; Yazım Hatasından Dolayı Farklı Olabilir.

Material : Cast Iron & Aluminum Cast
Paint & Colours: Unpainted (Painting Depending On Request)
The measurements of some of the products can vary due to writing errors

BANK ve AYAK MODELLERİ



230 cm
72 cm



72 cm

37 cm

46 cm

BN-112 Pik:43.000 gr



117 cm

72 cm

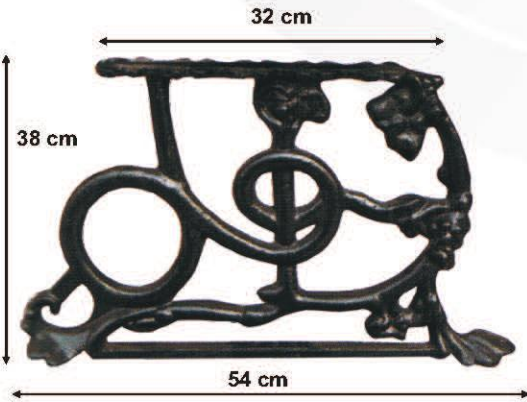

32 cm

38 cm

54 cm

BN-113 Pik:20.300 gr



135 cm

40 cm



Malzeme: Pik Döküm (İstenirse Alüminyum Döküm Yapılır.)
Boya & Renk: Boyasız (İsteğe Göre Boyanır.)
Bazı Ürünlerin Ölçüleri; Yazım Hatasından Dolayı Farklı Olabilir.

Material : Cast Iron & Aluminum Cast
Paint & Colours: Unpainted (Painting Depending On Request)
The measurements of some of the products can vary due to writing errors

BANK ve AYAK MODELLERİ

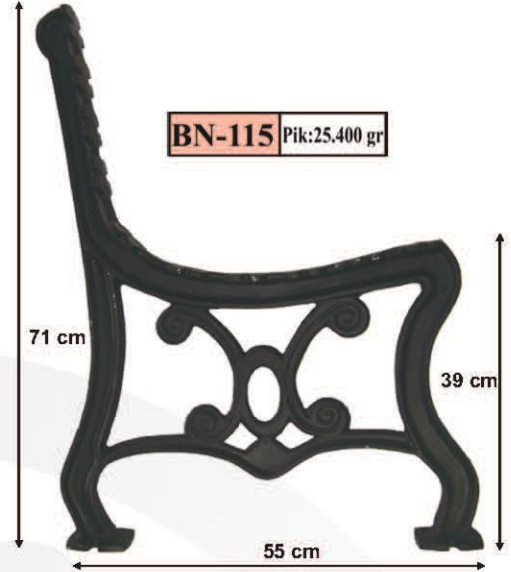
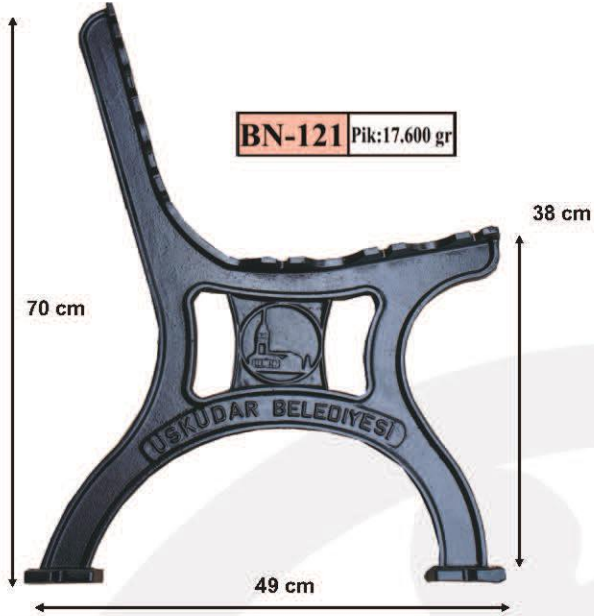

*İstenilen, İsim ve Logo BN-121 Kodlu Bank Üzerine Yazılabilir.

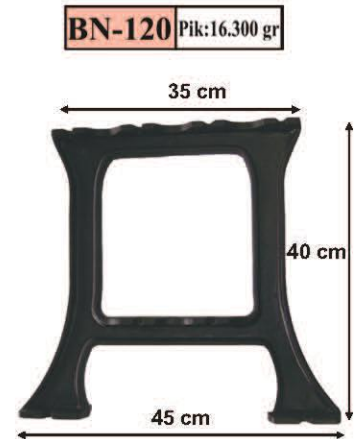
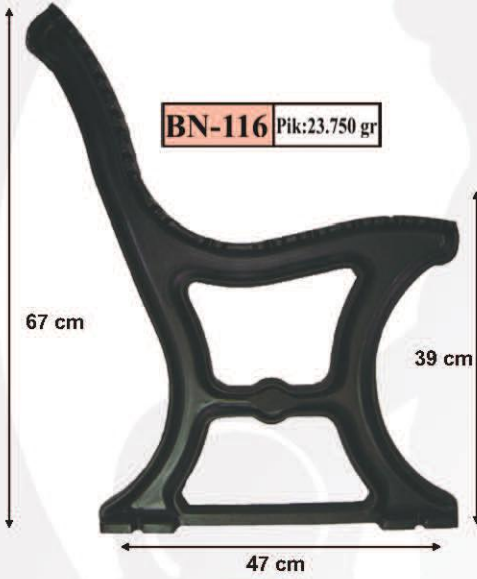

Malzeme: Pik Döküm (İstenirse Alüminyum Döküm Yapılır.)
Boya & Renk: Boyasız (İsteğe Göre Boyanır.)
Bazı Ürünlerin Ölçüleri; Yazım Hatasından Dolayı Farklı Olabilir.

Material : Cast Iron & Aluminum Cast
Paint & Colours: Unpainted (Painting Depending On Request)
The measurements of some of the products can vary due to writing errors

MASA MODELLERİ

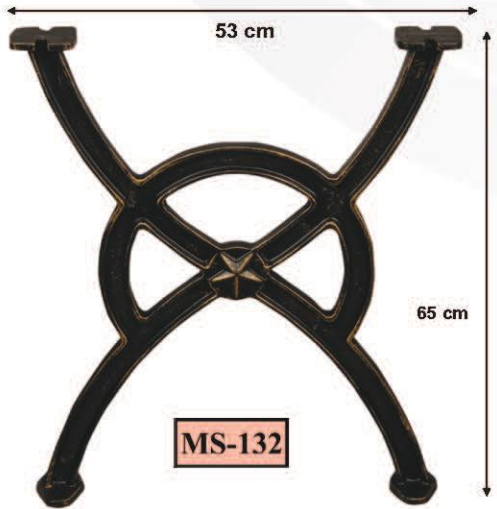
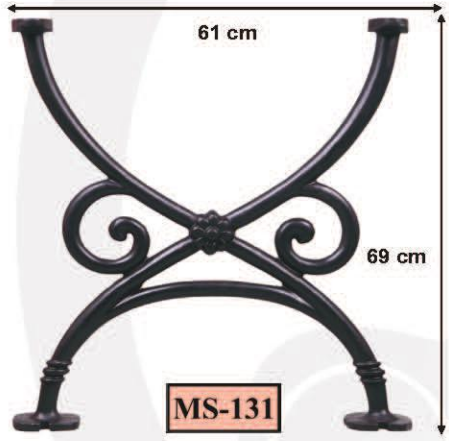
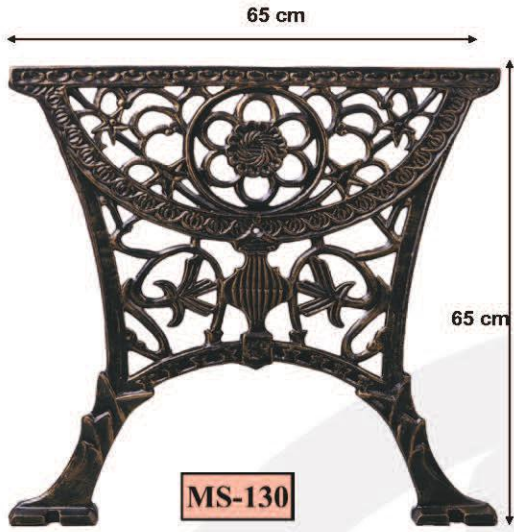

Malzeme: Pik Döküm (İstenirse Alüminyum Döküm Yapılır.)
Boya & Renk: Boyasız (İsteğe Göre Boyanır.)
Bazı Ürünlerin Ölçüleri; Yazım Hatasından Dolayı Farklı Olabilir.

Material : Cast Iron & Aluminum Cast
Paint & Colours: Unpainted (Painting Depending On Request)
The measurements of some of the products can vary due to writing errors

IZGARA MODELLERİ

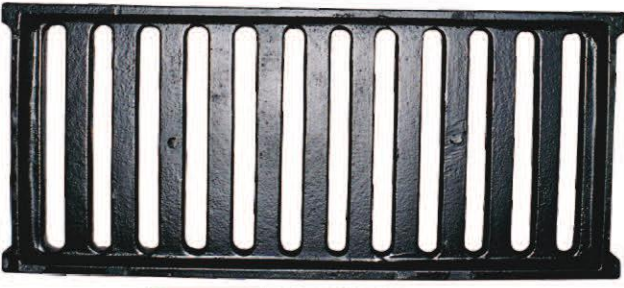

I-100 Pik=6.00 kg g
190*390*3.5 mm

I-101 Pik=5.00 kg
190*390*2.5 mm

I-102 Pik=10.00 kg
250*500*3.5 mm



I-103 Pik=24.00 kg
300*480*3.5 mm

I-104 Pik=21.00 kg
250*500*38 mm

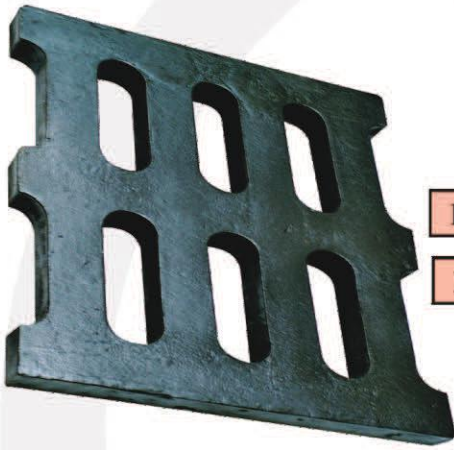

I-105 Pik=27.00 kg
400*400*3.5 mm

I-106 Pik=45.00 kg
400*500*4.5 mm

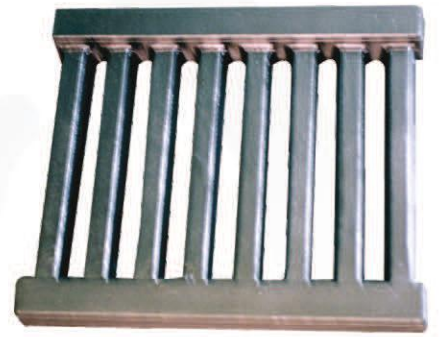

I-107 Pik=25.00 kg
400*400*50 mm



I-108 Pik= 78.00 kg
1000*1000*25 mm

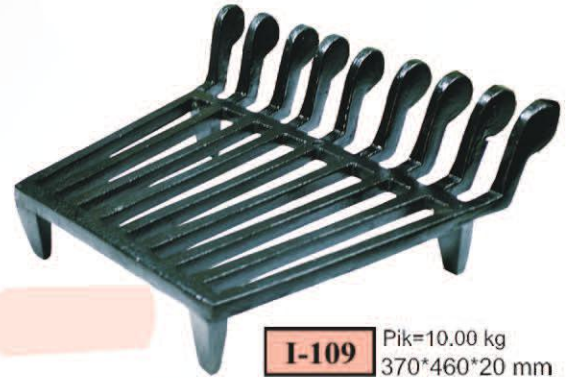

I-109 Pik=10.00 kg
370*460*20 mm

Ağaç Izgarası: Ortadaki Delik Çapı
Ağaç Büyüklüğüne Göre Büyütülür.

I-110 Pik=56.20 kg
690*400*4.5 mm

I-111 Pik=32.40 kg
370*500*40 mm

I-112 Pik=11.00 kg
200*400*50 mm

I-113 Pik=18.50 kg
200*490*40 mm

I-114 Pik=94.50 kg
690*400*70 mm

I-115 Pik=23.20 kg
470*400*80 mm

I-116 150*500*40 mm

İstenilen Her Ölçüye Göre Izgara İmalatı Yapılır.
Fiyatlar Kg Bazında Değerlendirilir.



Malzeme: Pik Döküm (İstenirse Alüminyum Döküm Yapılır.)
Boya & Renk: Boyasız (İsteğe Göre Boyanır.)
Bazı Ürünlerin Ölçüleri; Yazım Hatasından Dolayı Farklı Olabilir.

Material : Cast Iron & Aluminum Cast
Paint & Colours: Unpainted (Painting Depending On Request)
The measurements of some of the products can vary due to writing errors

AYDINLATMA MODELLERİ

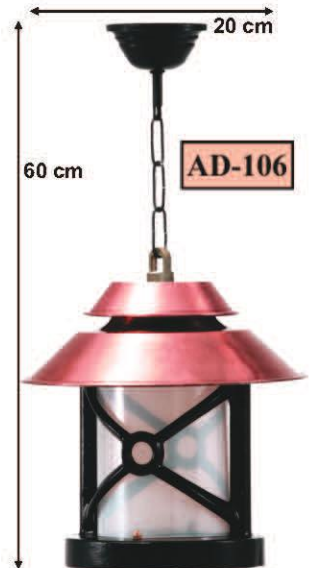
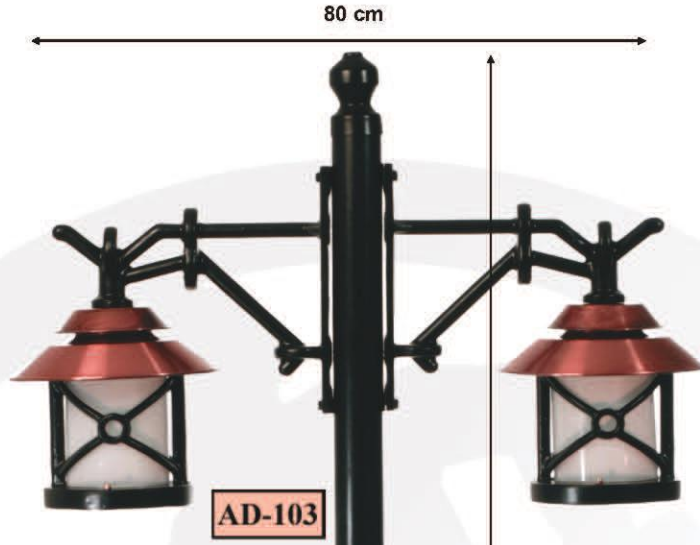

Malzeme: Alüminyum Döküm-Gövde: Pik Döküm, Çelik Boru
Armatür: Alüminyum Döküm-Bakır Sıvama Camı: Polikarbon (PC)
Boya & Renk: Boyasız (İsteğe Göre Boyanır.)
Bazı Ürünlerin Ölçüleri; Yazım Hatasından Dolayı Farklı Olabilir. 67

Material : Aluminum Cast - Bady: Cast Iron, Stell Pipe
Armature: Aluminum Cast - Copper Coaling Glass: Polycarbonate (PC)
Paint & Colours: Unpainted (Painting Depending On Request)
The measurements of some of the products can vary due to writing errors

AYDINLATMA MODELLERİ



Malzeme: Alüminyum Döküm, Çelik Boru
Armatür: Alüminyum Döküm Camı: Polikarbon (PC)
Boya & Renk: Elektrostatik - Siparişe Göre.
Bazı Ürünlerin Ölçüleri; Yazım Hatasından Dolayı Farklı Olabilir. 68

Material : Aluminum Cast , Steel Pipe
Armature: Aluminum Cast Glass: Polycarbonate (PC)
Paint & Colours: Electostatic - Mode To Order
The measurements of some of the products can vary due to writing errors



AYDINLATMA MODELLERİ



Malzeme: Alüminyum Döküm, Direk: PİK Döküm
Armatür: Alüminyum Döküm Camı: Cam
Boya & Renk: Elektrostatik - Siparişe Göre.
Bazı ürünlerin ölçüleri; Yazım Hatasından Dolayı Farklı Olabilir. 69

Material : Aluminum Cast , Steel Pipe
Armature: Aluminum Cast Glass: Glass
Paint & Colours: Electostatic - Mode To Order
The measurements of some of the products can vary due to writing errors



AYDINLATMA MODELLERİ

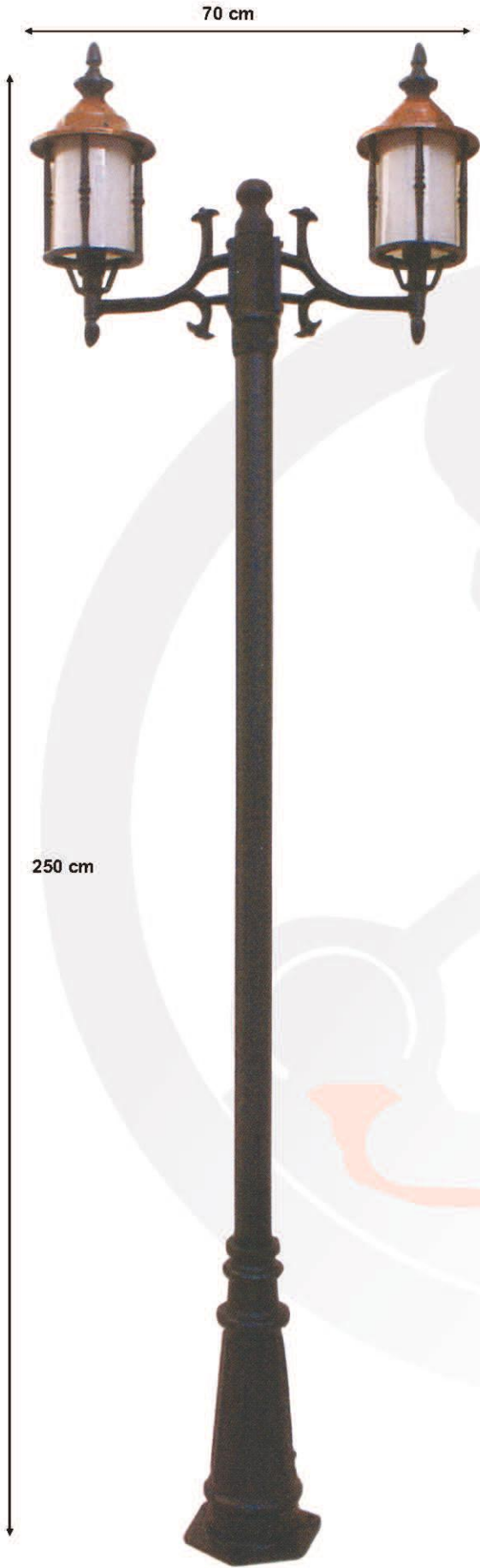

AD-121



AD-123



AD-124



AD-125



AD-122



Malzeme: Alüminyum Döküm,-Gövde: Pk Döküm, Çelik Boru
Armatür:Alüminyum Döküm - Bakır Sıvama Camı: Polikarbon (PC)
Boya &Renk: Elektrostatik - Siparişe Göre.
Bazı Ürünlerin Ölçüleri; Yazım Hatasından Dolayı Farklı Olabilir.

Material : Aluminum Cast , - Bady: Cast Iron, Stel Pipe
Armature: Aluminum Cast - Copper Coaling Glass: Polycarbonate (PC)
Paint &Colours: Electostatic - Mode To Order
The measurements of some of the products can vary due to writing errors

AYDINLATMA MODELLERİ

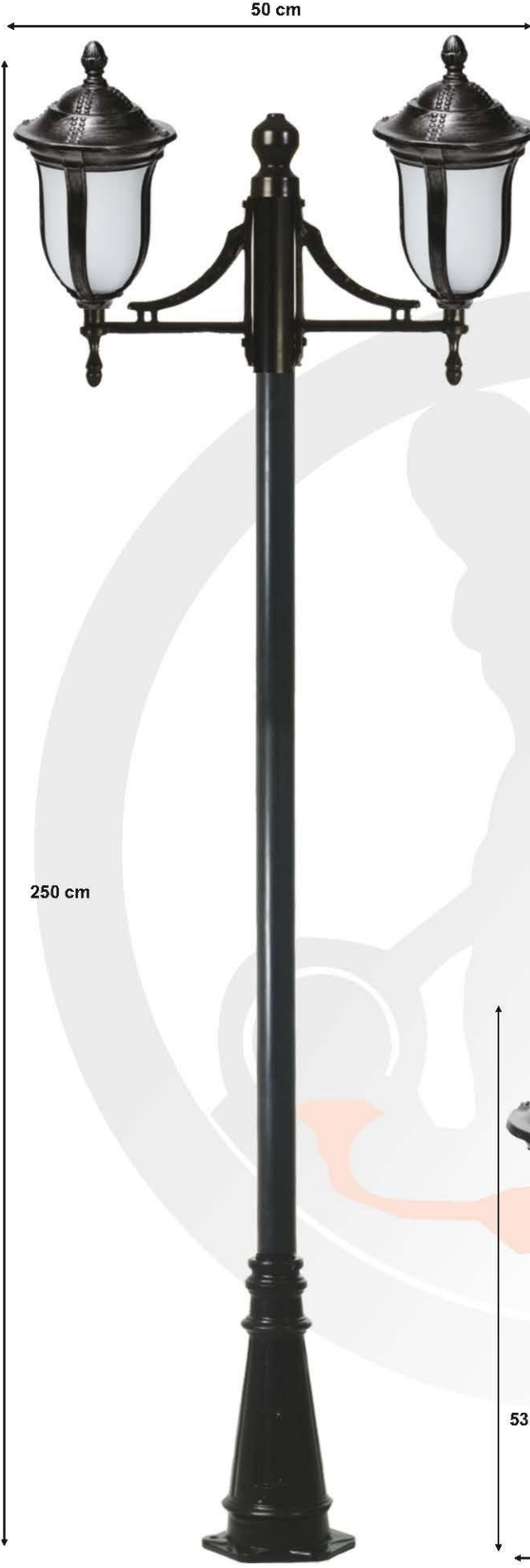

Malzeme: Alüminyum Döküm,-Gövde: Pük Döküm, Çelik Boru
Armatür:Alüminyum Döküm Camı: Polikarbon (PC)
Boya &Renk: Elektrostatik - Siparişe Göre.
Bazı Ürünlerin Ölçüleri; Yazım Hatasından Dolayı Farklı Olabilir.

Material : Aluminum Cast , - Bady: Cast Iron, Stell Pipe
Armature: Aluminum Cast Glass: Polycarbonate (PC)
Paint &Colours: Electostatic - Mode To Order

AYDINLATMA MODELLERİ



Malzeme: Alüminyum Döküm, - Direk: Çelik Boru
Armatür: Alüminyum Döküm Camı: Polikarbon (PC)
Boya & Renk: Elektrostatik - Siparişe Göre.
Bazı Ürünlerin Ölçüleri; Yazım Hatasından Dolayı Farklı Olabilir.

Material : Aluminum Cast , - Stell Pipe
Armature: Aluminum Cast Glass: Polycarbonate (PC)
Paint & Colours: Electostatic - Mode To Order

AYDINLATMA MODELLERİ



Malzeme: Alüminyum Döküm, - Gövde: Pik Döküm, Çelik Boru
Armatür: Alüminyum Döküm Camı: Polikarbon (PC)
Boya & Renk: Elektrostatik - Siparişe Göre.
Bazı Ürünlerin Ölçüleri; Yazım Hatasından Dolayı Farklı Olabilir.

Material : Aluminum Cast , - Bady: Cast Iron, Stell Pipe
Armature: Aluminum Cast Glass: Polycarbonate (PC)
Paint & Colours: Electostatic - Mode To Order

AYDINLATMA MODELLERİ

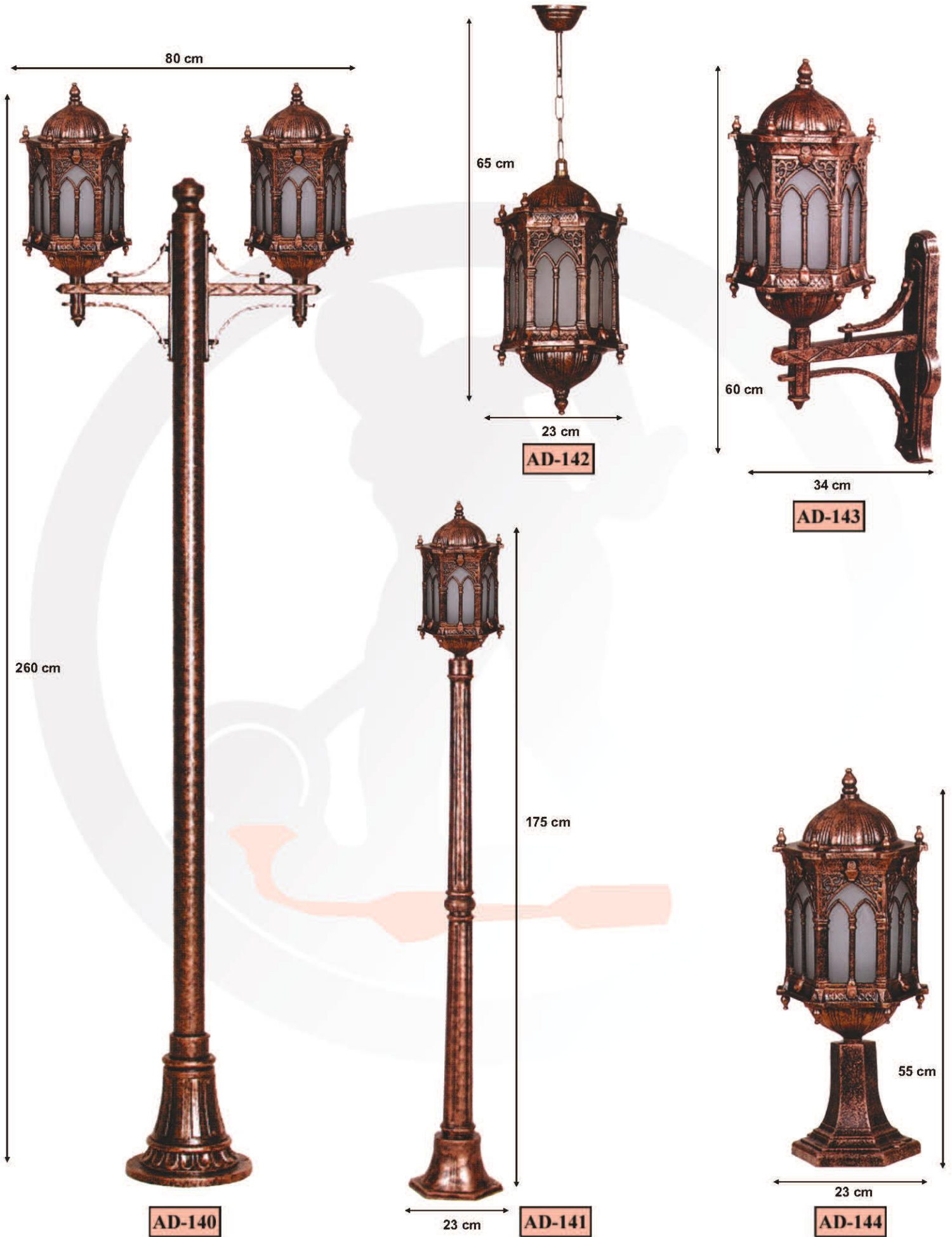

Malzeme: Alüminyum Döküm, Çelik Boru
Armatür: Alüminyum Döküm Camı: Polikarbon (PC)
Boya & Renk: Elektrostatik - Siparişe Göre.
Bazı Ürünlerin Ölçüleri; Yazım Hatasından Dolayı Farklı Olabilir.

Material : Aluminum Cast, Stel Pipe
Armature: Aluminum Cast Glass: Polycarbonate (PC)
Paint & Colours: Electostatic - Mode To Order
The measurements of some of the products can vary due to writing errors

AYDINLATMA MODELLERİ



AD-145



AD-147



AD-146



AD-148



Malzeme: Alüminyum Döküm, Çelik Boru
Armatür: Alüminyum Döküm Camı: Polikarbon (PC)
Boya & Renk: Elektrostatik - Siparişe Göre.
Bazı Ürünlerin Ölçüleri; Yazım Hatasından Dolayı Farklı Olabilir.

Material : Aluminum Cast, Steel Pipe
Armature: Aluminum Cast Glass: Polycarbonate (PC)
Paint & Colours: Electostatic - Mode To Order
75 The measurements of some of the products can vary due to writing errors

AYDINLATMA MODELLERİ



Malzeme: Alüminyum Döküm, - Direk: Pik Döküm
Armatür: Alüminyum Döküm Camı: Cam
Boya & Renk: Elektrostatik - Siparişe Göre.
Bazı Ürünlerin Ölçüleri; Yazım Hatasından Dolayı Farklı Olabilir.

Material : Aluminum Cast, - Pole: Cast Iron
Armature: Aluminum Cast Glass: Glass
Paint & Colours: Electostatic - Mode To Order
The measurements of some of the products can vary due to writing errors

AYDINLATMA MODELLERİ



Malzeme: Alüminyum Döküm, Çelik Boru
Armatür: Alüminyum Döküm Camı: Polikarbon (PC)
Boya & Renk: Elektrostatik - Siparişe Göre.
Bazı Ürünlerin Ölçüleri; Yazım Hatasından Dolayı Farklı Olabilir.

Material : Aluminum Cast, Steel Pipe
Armature: Aluminum Cast Glass: Polycarbonate (PC)
Paint & Colours: Electrostatic - Mode To Order
The measurements of some of the products can vary due to writing errors

AYDINLATMA MODELLERİ

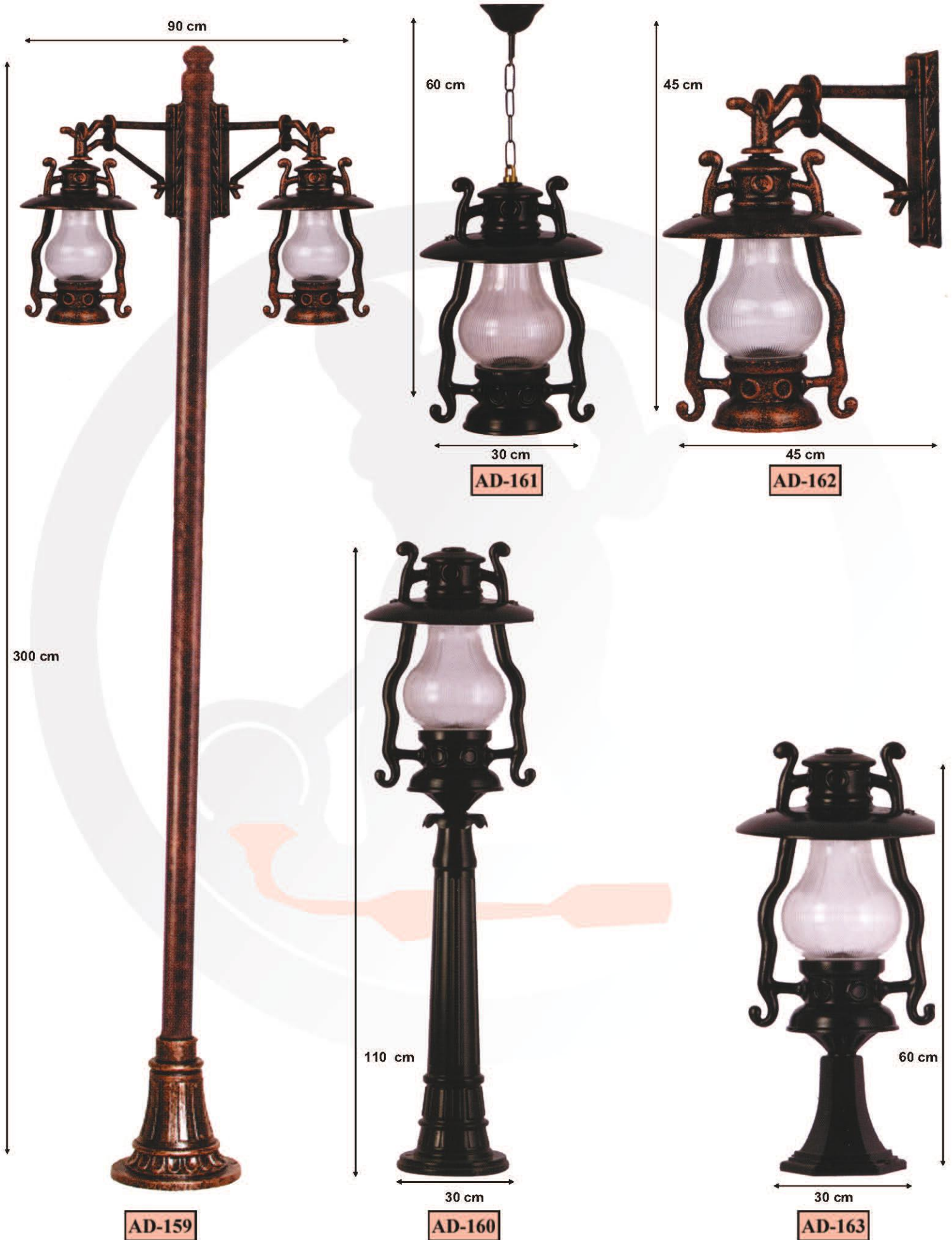

Malzeme: Alüminyum Döküm, Çelik Boru
Armatür: Alüminyum Döküm Camı: Polikarbon (PC)
Boya & Renk: Elektrostatik - Siparişe Göre.
Bazı Ürünlerin Ölçüleri; Yazım Hatasından Dolayı Farklı Olabilir.

Material : Aluminum Cast, Steel Pipe
Armature: Aluminum Cast Glass: Polycarbonate (PC)
Paint & Colours: Electrostatic - Mode To Order
The measurements of some of the products can vary due to writing errors

AYDINLATMA MODELLERİ



Malzeme: Alüminyum Döküm, Gövde: PİK Döküm Çelik Boru
Armatür: Alüminyum Döküm - Bakır Sıvama Camı: Polikarbon (PC)
Boya & Renk: Elektrostatik - Siparişe Göre.
Bazı Ürünlerin Ölçüleri; Yazım Hatasından Dolayı Farklı Olabilir.

Material : Aluminum Cast,- Bady: Cast Iron, Stel Pipe
Armature: Aluminum Cast - Copper Coaling Glass: Polycarbonate (PC)
Paint & Colours: Electostatic - Mode To Order
The measurements of some of the products can vary due to writing errors

Uygulamalar



UYGULAMA 1



UYGULAMA 2



UYGULAMA 3



UYGULAMA 4



UYGULAMA 5



UYGULAMA 6

"Dökümün Sanata Dönüştüğü Yer"



Uygulamalar



UYGULAMA 7



UYGULAMA 8



UYGULAMA 9



UYGULAMA 10



UYGULAMA 11



UYGULAMA 72

"Dökümün Sanata Dönüştüğü Yer"



Uygulamalar



UYGULAMA 73



UYGULAMA 14



UYGULAMA 15



UYGULAMA 74



UYGULAMA 17

"Dökümün Sanata Dönüştüğü Yer"



Uygulamalar



UYGULAMA 18



UYGULAMA 19



UYGULAMA 20



UYGULAMA 21



UYGULAMA 75



UYGULAMA 23

"Dökümün Sanata Dönüştüğü Yer"



Uygulamalar



UYGULAMA 24



UYGULAMA 25

"Dökümün Sanata Dönüştüğü Yer"



Uygulamalar



UYGULAMA 26

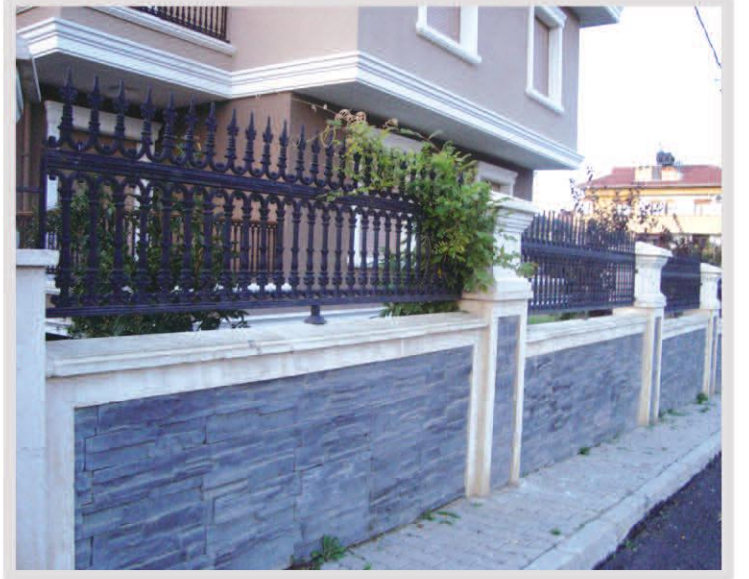

UYGULAMA 27



UYGULAMA 28



UYGULAMA 29



UYGULAMA 76



UYGULAMA 31

"Dökümün Sanata Dönüştüğü Yer"



Uygulamalar



UYGULAMA 77



UYGULAMA 33



UYGULAMA 34



UYGULAMA 35

"Dökümün Sanata Dönüştüğü Yer"



Uygulamalar



UYGULAMA 78



UYGULAMA 37



UYGULAMA 79



UYGULAMA 39



UYGULAMA 40

"Dökümün Sanata Dönüştüğü Yer"



Uygulamalar



UYGULAMA 80



UYGULAMA 42



UYGULAMA 43



UYGULAMA 81

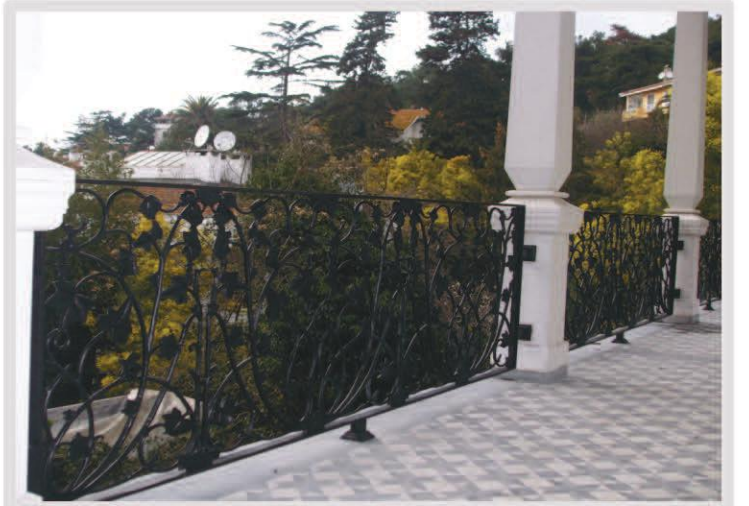

UYGULAMA 45

"Dökümün Sanata Dönüştüğü Yer"



Uygulamalar



UYGULAMA 46



UYGULAMA 47



UYGULAMA 48



UYGULAMA 82



UYGULAMA 50



UYGULAMA 51

"Dökümün Sanata Dönüştüğü Yer"



Uygulamalar



UYGULAMA 52



UYGULAMA 53



UYGULAMA 83

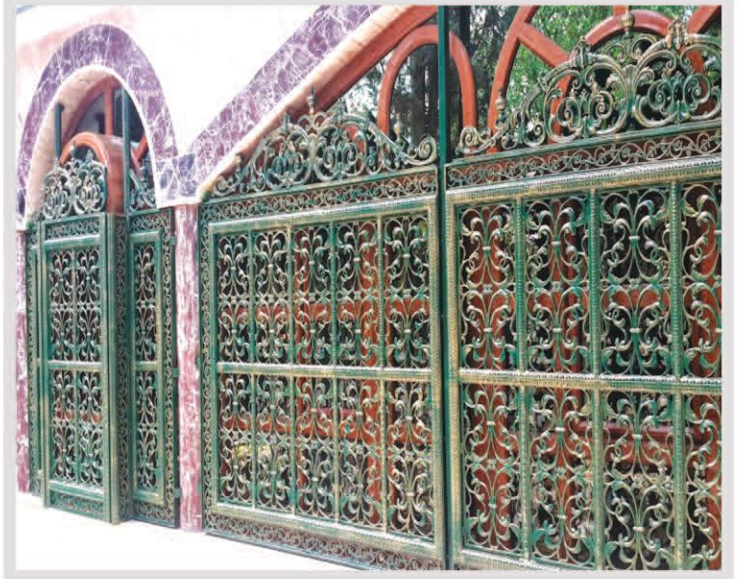

UYGULAMA 84



UYGULAMA 56



UYGULAMA 57



UYGULAMA 58

"Dökümün Sanata Dönüştüğü Yer"



Uygulamalar



UYGULAMA 59



UYGULAMA 85



UYGULAMA 86

"Dökümün Sanata Dönüştüğü Yer"



Uygulamalar



UYGULAMA 87



UYGULAMA 82



UYGULAMA 63



UYGULAMA 88

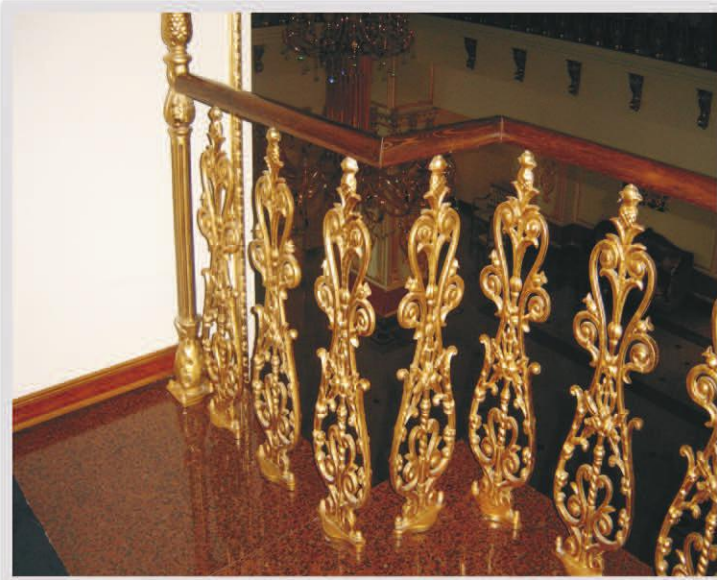

UYGULAMA 64



UYGULAMA 89

"Dökümün Sanata Dönüştüğü Yer"



Uygulamalar

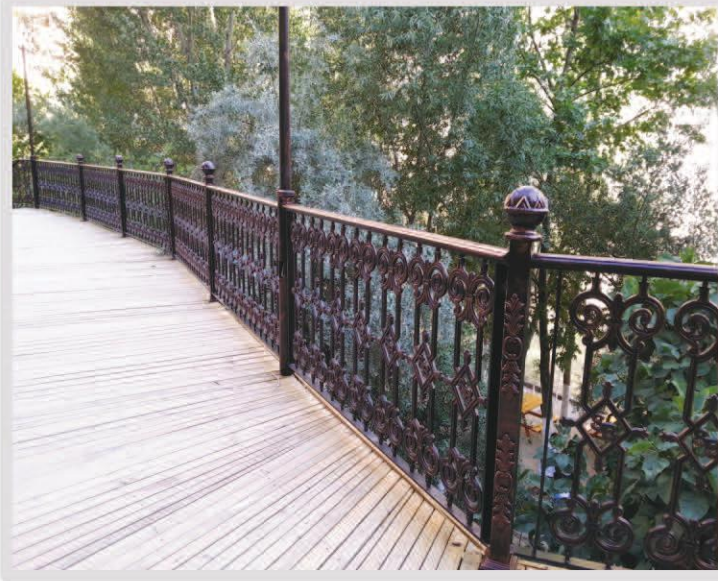

UYGULAMA 90



UYGULAMA 91



UYGULAMA 92



UYGULAMA 93

"Dökümün Sanata Dönüştüğü Yer"



Uygulamalar



UYGULAMA 94



UYGULAMA 95



UYGULAMA 96



UYGULAMA 97

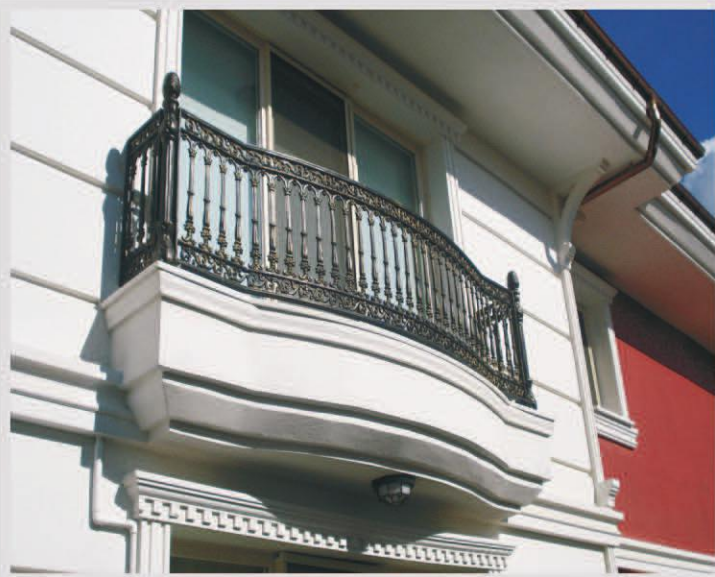

UYGULAMA 98



UYGULAMA 99

"Dökümün Sanata Dönüştüğü Yer"



Uygulamalar



UYGULAMA 100



UYGULAMA 101



UYGULAMA 102

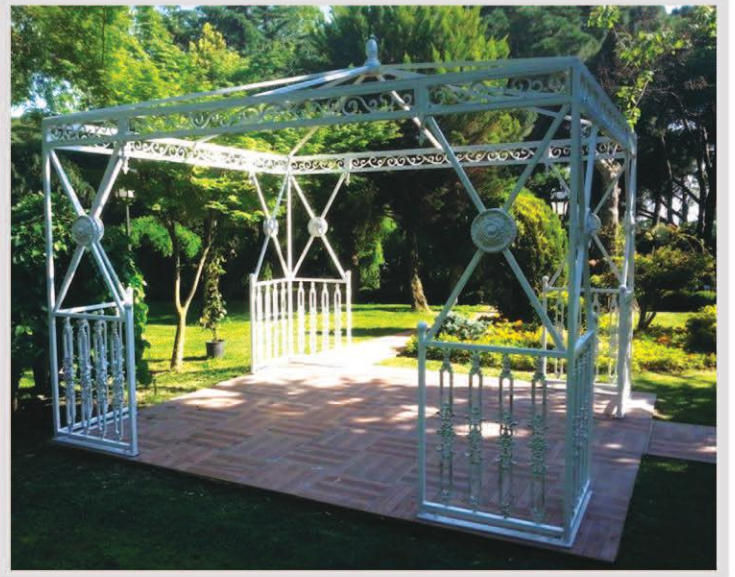

UYGULAMA 103

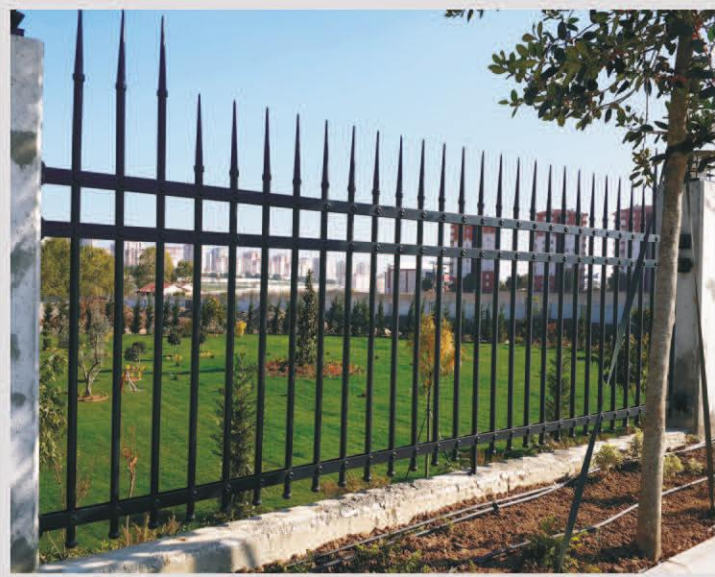

UYGULAMA 104



UYGULAMA 105

"Dökümün Sanata Dönüştüğü Yer"



Uygulamalar



UYGULAMA 106



UYGULAMA 67



UYGULAMA 107



UYGULAMA 108



UYGULAMA 70

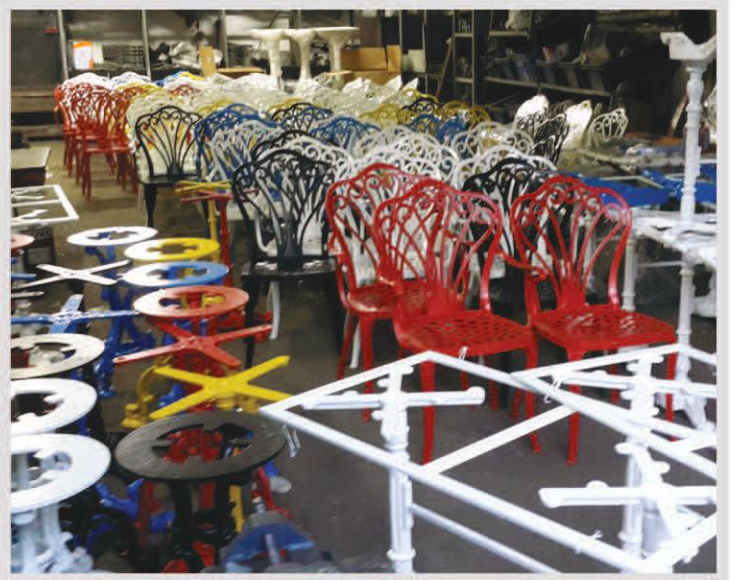

UYGULAMA 109

"Dökümün Sanata Dönüştüğü Yer"

